

Healthcare Storage Solutions

Organize Supplies • Reduce Inventory • Utilize Space



Promptii



Benefits of Kanban for Healthcare:

- Organization of supplies.
- Stock is rotated to reduce expired supplies.
- Reduces time to find supplies.
- Gives time back to clinical staff for care of patients.
- Reduce unnecessary inventory holding.
- Major cost and time savings.

What is Kanban?

Kanban is Japanese for “signboard” or “billboard” and is a system for scheduling the movement of inventory through the use of visual indicators. Identifying when a supply container is empty and needs to be refilled is a crucial component of any inventory management system.

How Kanban Works

Kanban is a highly effective method of managing inventory through the use of visual cues to alert when items need to be restocked. A Kanban system can be implemented using a two-bin system, a single-bin system, a side-by-side system, Kanban cards or indicator flags.

Two-Bin Kanban System

The most popular type of Kanban system uses two bins filled with the same item. The bins are placed on a shelf one in front of the other. When the front bin is empty, the nurse removes it and places it on the top shelf to show that the bin needs to be refilled. The rear bin is pulled to the front for picking. Once the empty bin is refilled, it is put behind the front bin so stock is rotated and items don't expire.



Shelf Bins, see pages 8-14

Kanban Cards

Kanban cards are placed on storage bins with detailed information about what's in the bin (part number, bar code, etc.). Once the items in the bin reach a minimum stock level, the card is removed and deposited in a location to notify the materials manager to reorder that item.

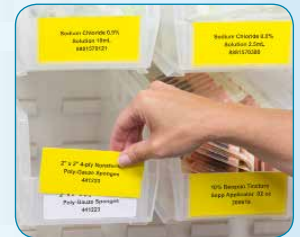

Use duplicate cards, in two different colors.

Single-Bin Kanban System

A single two-sided bin with one end being a brightly colored stock “indicator” is used to hold supplies. A divider marks the minimum stock holding level. Once the primary stock is empty, the bin is turned around to reveal the brightly colored indicator side of the bin. This is a visual cue that the bin needs to be refilled.

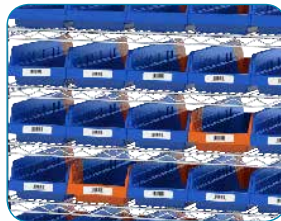

Indicator® Bins, see page 14



Benefits of 5S for Healthcare:

- Eliminate waste and redundancies.
- Create extra workspace.
- Tighten inventory levels.
- Reduce inventory cost.
- Find supplies quickly using a standardized color-coded sorting system.

What is 5S Lean?

5S Lean is a methodology to improve efficiencies and enhance operational excellence. These proven steps include:

1. Sort
2. Set In Order
3. Shine
4. Standardize
5. Sustain



Before



After

Convert your workplace to 5S Lean with innovative products from Promplii.

Organizations that invest in a 5S process gain productivity, create a higher quality product and lower operating costs by simply implementing a system of waste removal, visual identification and efficient use of space.

5S Lean Solutions

Sort | Set in Order | Shine | Standardize | Sustain

5S Lean Healthcare Solutions:

Increase Efficiency and Organization with 5S Lean!

A well-organized supply room is critical in medical, pharmacy or laboratory settings. Extra time spent by physicians, ancillary staff, and nursing staff searching for supplies can affect the quality of care being given to your patients.

By incorporating industry-leading products, you can easily:

- Improve work flow and productivity.
- Reduce PAR levels.
- Develop a cleaner, more efficient environment.
- Create extra workspace.
- Increase safety.
- Reduce wasted time and effort.
- Boost employee morale.
- Ensure improvements remain intact.



Sort:

Sort it out! The first step is to organize the work areas, leaving only those tools and materials necessary to perform daily activities.

- Use storage bins to sort and separate like parts in small or large work spaces.
- Bins feature large hopper front for easy access and faster picking.
- Promplii bins are available in multiple sizes and colors for total visualization.
- Clear bins provide maximum visibility and easy identification of supplies.
- Shelf bins and totes will fit on new or existing shelving systems.



Set in Order:

Frequently used work station materials and tools should be arranged so that all needed items are easy to get to and accessible for anyone to find.

Organize:

- Work areas should be organized in a way that makes the most efficient use of shelving, racks, counter areas and floor space, keeping frequently used items within reach.
- Hanging and stacking bins, shelf bins and totes let you store items used together close to each other.
- Orderliness eliminates waste in production and clerical activities.
- Label both the bin and its space on the shelf to ensure parts are always returned to the proper location.



Create Space:

- Louvered hanging systems create vertical storage and help to make the most of an area.
- Wire and steel shelving systems create customized storage to fit any workspace.
- Mobile systems are versatile that keep items organized and within reach at all times.

5S Lean Solutions

Sort | Set in Order | Shine | Standardize | Sustain

Shine:

Prevent dirt from accumulating and develop a cleaning maintenance schedule to help protect parts and equipment from dirt, dust, and debris.

- Store materials securely with lids to keep items clean and protected.
- Grid containers have divider options to customize individual compartments for parts, plus optional lids to keep out dust and debris.
- Many Promplii plastic products are resistant to oils, chemicals, and weak acids.
- Drawer bins with enclosed shelving systems help keep supplies, parts, and tools secure and dust free.
- Easy to clean nest and stack containers, attached lid and detached lid containers nest when empty for efficient organization and storage.



Standardize:

Benchmarking and evaluation tactics should be utilized to maintain a consistent approach for carrying out tasks and procedures.

Work Flow:

- Never run out of inventory by implementing a Kanban system.
- Indicator two-tone bins simplify visual recognition when supplies need to be replenished - never run out again!
- Super-sized bins securely stack on top each other, ensuring items stay in their proper places.
- Portable work centers allow for easy mobility and integration of 5S duties into regular work responsibilities.



Stock | Pick | Flip | Replenish

Consistency:

- By standardizing operation work stations, non-value-added tasks are removed or corrected, which reduces downtime and increases output and efficiency.
- Bins, carts, and hoppers help create universal standards for each process such as color coding, labeling and uniform sizes.



Sustain:

A disciplined and committed work flow process empowers workers to improve and maintain the workplace. When employees take pride in their work, it leads to greater job satisfaction and higher productivity.

Continue:

- Reinforcing and evaluating best practices will keep waste out of the process and provide a solid foundation from which to build improvements in the future.
- Our plastic and steel material handling products promote effective storage, organization, and transport systems to boost efficiency and reduce costs in any work environment.



Index

Hanging and Stacking Bins - Page 7

- The industry-leading hanging and stacking bin.
- Bins stack, sit on shelving, and hang.
- Guaranteed not to crack or break under normal load conditions.



4" Shelf Bins - Page 8

- Bins work with 12", 18" and 24" deep storage.
- Industrial-grade bins outlast corrugated bins.
- Built-in rear hang lock allows bins to tilt out for complete access.



6" Shelf Bins - Page 9

- 6" tall bins allow more storage space than traditional 4" Bins.
- Reinforced ribs for added strength.
- Bins work with 12", 18" and 24" deep storage.



Stack and Store Bins - Page 10

- Wide hopper front for easy access.
- Same size bins can be stacked on top one another on flooring or shelving.
- Stacking bins are ideal for large, bulky items.



1800 Series Bins - Page 11

- Storage system for heavy, bulky items.
- Stackable with reinforcing ribs to prevent spreading under heavy loads.
- Front and back finger grips for easy handling.



High Visibility Shelf Bins - Page 11

- Large hopped front for maximum visibility of contents.
- Works with standard steel and wire shelving or gravity flow racks.



Super Sized Bins - Page 12

- Perfect for organizing and protecting large or bulky items.
- Heavy-duty bins stack securely on top of each other or sit on shelving.



Drawer Bins - Page 13

- Keep supplies and parts secure and dust-free.
- Drawers can be used with Cabinets, Shelving, and more.



System Bins - Page 13

- Designed to fit on a 36" wide steel or wire shelving, cabinets and drawers.
- Sturdy interior double-wall construction.
- Smooth surfaces are easy to handle and clean.

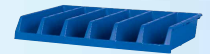

Indicator Bins - Page 14

- Two-tone Kanban bins offer inventory control at a glance.
- Bright color triggers low stock levels.
- Bin can be picked from both sides.

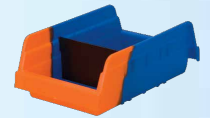

InSight and Wire Bins - Page 15

- Ultra-clear polycarbonate and wire bins provide easy visibility of contents.
- Bins securely stack and hang from louvered panels and rails.

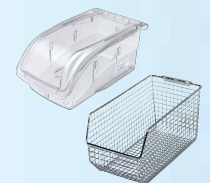

Tilt View Bins - Page 16

- Cabinets and cups made of durable polystyrene.
- Stone color is ideal for a variety of medical settings.



Tote Caddy - Page 17

- Compact, hand-held supply caddy.
- Designed to hold loose items, medical and cleaning supplies or tools for easy transport.
- The perfect phlebotomy caddy!



Supply Box - Page 17

- Removable tray keeps smaller items quickly accessible.
- Oversized padlock eye accepts a variety of padlocks or zip ties in order to make the box tamper-evident.



Louvered Panels - Page 18

- Customizable vertical storage for hanging bins.
- Available in panels and racks.
- Compatible with a large variety of hanging bin sizes.

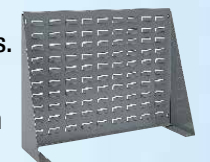

Rail Racks - Page 19

- Steel rail racks securely support Hanging and Stacking Bins, InSight® Bins, or Steel Cabinets (sold separately).
- Heavy-duty steel for strength and durability.



Index

19 Series Cabinets - Page 20

- Great for organizing small items such as dental instruments or lab supplies.
- Keep inventory accurate and dust free.
- Clear windows provide visibility of contents.



Pick Racks - Page 20

- Available in single-sided, double-sided, and bench models.
- Work with a variety of plastic storage bins.
- Durable powder-coated finish.



Security Cabinets - Page 21

- Heavy Duty All-Welded bin storage cabinets.
- Compatible with hanging and stacking bins.
- Lockable cabinets for content security.
- Available in multiple sizes and configurations.



Wire Shelving/Accessories- Page 22-25

- Constructed from steel with a durable chrome finish.
- Open wire design minimizes dust and improves visibility of stored contents.



Stack and Nest Containers - Page 26-27

- Stack with or without lids for convenient storage and shipping.
- Totes nest when empty.
- Manufactured from FDA-approved materials.



Fiberglass Reinforced Totes - Page 28

- Fiberglass reinforced containers nest when empty and stack when full by rotating 180°.
- High operating temp range of -60° to 250° F.
- High weight capacity.



Attached Lid Container - Page 29-30

- Securely store and transport supplies.
- Maximum product protection.
- Smooth interior for easy cleaning.
- Stack when full, nest when empty.



Detached Lid Containers - Page 30

- Containers stack firmly with lids, nest when empty for optimum space utilization.
- Detached lids snap tight for secure closure.
- Secure with optional tote snaps, zip ties, etc.



Grid Containers - Page 31

- Create custom sized compartments using optional lengthwise and crosswise dividers.
- Great for organizing items and creating kits of items that are frequently used together.

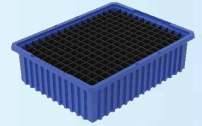

ProCart - Page 32

- Box cart or flat top, all in one!
- Versatile, all-purpose plastic utility cart.
- Quickly move supplies through your facility.
- Resists dents, rust proof, never needs painting.



Linen and Waste Carts - Page 33-34

- Thick, rugged walls for added durability.
- Seamless bodies will not crack, chip, fade, rust, dent, splinter or corrode.
- Designed for safe and easy loading/unloading.



Tilt Trucks - Page 35

- Thick, rugged tub walls for added durability and resistance to impact.
- Wheel base and heavy-duty caster combination provides easy maneuverability even with heavy loads.



Waste and Recycling - Page 36-37

- Recycling and waste disposal in one unit.
- Smooth ergonomic design for easy cleaning.
- A range of attractive colors and sizes.



Platform Trucks - Page 38

- Non-skid structural foam deck is easy-to-clean and won't rot, chip or rust.
- Handles and rails feature a durable, powder-coated finish.



Fire Safety Storage - Page 38

- Durable, rust and acid resistant.
- In full compliance with OSHA and NFPA standards.
- Sturdy all welded construction.



Lockers - Page 39

- Premium all purpose lockers with traditional louvered doors are designed for storage of all personal belongings.
- Lockers can be ordered fully-assembled or knock-down for assembly at the destination.



CLEAR

STORAGE SOLUTIONS

Save Time Looking For Supplies!

Clear Bins Provide:

- Maximum Visibility.
- Easy Parts Identification.
- Optimized Storeroom Efficiency.



4" Shelf Bin
30120SCLAR



Hanging and Stacking Bin
30230SCLAR



Super-Size Bin
30286SCLAR



6" Shelf Bin
30098SCLAR



Stack and Store Bin
13017SCLAR



InSight® Bin
305B1



Supply Box
09514CFT



Drawer Bin
31168SCRY



Attached Lid Container
66486CLDBL

Contents

Storage Bins and Caddies	Page 7-17
Louvered Panels, Rail and Racks	Page 18-20
Security Cabinets	Page 21
Wire Shelving Units and Components	Page 22-25
Totes and Containers	Page 26-31
Carts, Trucks and Dollies	Page 32-35
Waste and Recycling Containers	Page 36-37
Safety Equipment	Page 38-39

Hanging and Stacking Bins

- Separate look-alike/sound-alike medications using different colors of bins.
- Multiple sizes and colors allow color coding (vertically and horizontally) and for easy identification of supplies.
- Molded of industrial-grade polymers.
- Bins sit on shelves or hang from panels, racks, rails and carts.
- Bins securely stack to optimize shelf space.
- Wide hopper fronts for easy access.



30230SCLAR



30230BLUE

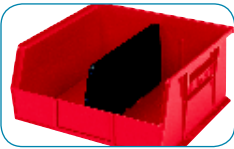

Lengthwise dividers keep items separated



"See-through" clear bin lids protect contents



Large front label slot for easy coding and scanning



30237 fits perfectly on 18" deep shelving for a two-bin Kanban system or rotate and pick from both sides.



AWS184830260GREEN Bin Wire System



30240BLUE and 30250BLUE bins paired with 30161 louvered panels.



30210YELLOW



30220BLACK



30230GREEN



30239RED



30235STONE



30240BLUE

Hanging and Stacking Bins		Outside Dimensions (In.)			Capacity/Quantity		Accessories				
Model No.	Available Colors	L	W	H	Bin Load Cap. On Rack	Bin Ctn. Qty.	Black Length Dividers**	Width Dividers**	Divider Pkg. Qty.	Bin Lids	Lid Pkg. Qty.
30210	R, B, Y, ST, GN, BK, SC	5-3/8	4-1/8	3	10 lbs.	24	40210 (1)	-	6	30211CRY	24
30220	R, B, Y, ST, GN, BK, SC	7-3/8	4-1/8	3	10 lbs.	24	40220 (1)	-	6	30221CRY	24
30237	R, B, Y, ST, GN, BK, SC	9-1/4	6	5	20 lbs.	12	40237 (1)	-	6	-	-
30224	R, B, Y, ST, GN, BK, SC	10-7/8	4-1/8	4	20 lbs.	12	40224 (1)	-	6	30225CRY	12
30230	R, B, Y, ST, GN, BK, SC	10-7/8	5-1/2	5	30 lbs.	12	40230 (1)	41230 (3)	6	30231CRY	12
30234	R, B, Y, ST, GN, BK, SC	14-3/4	5-1/2	5	50 lbs.	12	40234 (1)	-	6	-	-
30239	R, B, Y, ST, GN, BK, SC	10-7/8	8-1/4	7	50 lbs.	6	40239 (1)	-	6	-	-
30240	R, B, Y, ST, GN, BK, SC	14-3/4	8-1/4	7	60 lbs.	12	40245 (1)	-	6	-	-
30265	R, B, Y, ST, GN, BK, SC	18	8-1/4	9	60 lbs.	6	40265 (1)	-	6	-	-
30235	R, B, Y, ST, GN, BK, SC	10-7/8	11	5	50 lbs.	6	40230 (3)	-	6	30236CRY	6
30260	R, B, Y, ST, GN, BK, SC	18	11	10	60 lbs.	6	40260 (3)	-	6	-	-
30255	R, B, Y, ST, GN, BK, SC	10-7/8	16-1/2	5	60 lbs.	6	40230 (3)	-	6	-	-
30250	R, B, Y, ST, GN, BK, SC	14-3/4	16-1/2	7	75 lbs.	6	40245 (3)	41250 (3)	6	-	-
30270	R, B, Y, ST, GN, BK, SC	18	16-1/2	11	75 lbs.	3	40270 (3)	41270 (3)	6	-	-
30320	R, B, Y, ST, GN, BK, SC	8-5/8	33	5	80 lbs.	4	40321 & 40220 (7)	-	7 / 6	-	4

*Other colors available with minimum order. Order in carton quantities. **() = Max. # of dividers per bin.

CAUTION: When using bins with hanging systems, do not exceed the weight capacity for the rack, which may be less than the total sum of bin capacities.

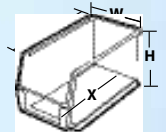

Bin Wire Systems			Shelf Dimensions (In.)			Quantity	
Model No.	Description	Available Colors	D	L	H	# of Bins	Shelves
AWS143630320	Wire Shelving w/ 30320 Bins	B, R, Y, S, SC	14	36	74	12	11
AWS143630240	Wire Shelving w/ 30240 Bins	B, R, Y, G, K, S, SC	14	36	74	36	4
AWS143630250	Wire Shelving w/ 30250 Bins	B, R, Y, G, K, S, SC	14	36	74	18	4
AWS184830260	Wire Shelving w/ 30260 Bins	B, R, Y, G, K, S, SC	18	48	74	24	6
AWS183630265	Wire Shelving w/ 30265 Bins	B, R, Y, G, S, SC	18	36	74	18	5
AWS183630270	Wire Shelving w/ 30270 Bins	B, R, Y, G, K, S, SC	18	36	74	9	5

*Other colors available with minimum order. Order in carton quantities.

4" Shelf Bins

- Keep supplies neat and organized.
- Create cleaner work areas, eliminate cardboard with reusable, Eco-friendly bins.
- Easy to label and color code for quick identification.
- Works with 12", 18" and 24" deep shelving.
- Bins nest when empty for space savings.
- Built in hang-lock allows bin to tilt out on shelving for complete access.
- Works in temperatures down to -20°F.
- Available in multiple colors and sizes.



30130SCLAR



30130BLUE



30138YELLOW



30164GREEN

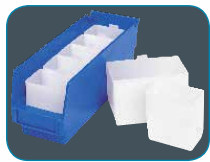

Bin cups lift out for easy access



Dividers create additional compartments

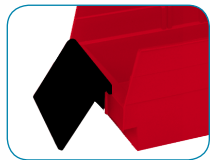

40445 Label Holder holds oversized labels or bar-codes.



30138BLUE with 40130 Dividers

Accessories		Outside Dimensions (In.)			Ctn. Qty.
Model No.	Description	L	W	H	
30101	Small Bin Cup	2	3-1/4	3	48
30102	Large Bin Cup	2-3/4	5	3	24
40410	10° Angle Extended Label Holder	-	4	2-1/4	24
40445	45° Angle Extended Label Holder	-	4	2-1/4	24

4" Shelf Bins		Outside Dimensions (In.)			Capacity/Quantity		Cups per Bin		Accessories	
Model No.	Available Colors	L	W	H	Bin Load Capacity	Ctn. Qty.	Small 30101	Large 30102	Width Dividers*	Divider Pkg. Qty.
30110	R, B, Y, G, SC	11-5/8	2-3/4	4	7 lbs.	24	3	-	-	-
30120	R, B, Y, G, SC	11-5/8	4-1/8	4	10 lbs.	24	5	2	40120 (7)	24
30130	R, B, Y, G, SC	11-5/8	6-5/8	4	15 lbs.	12	9	4	40130 (7)	24
30150	R, B, Y, G, SC	11-5/8	8-3/8	4	15 lbs.	12	11	4	40150 (7)	24
30170	R, B, Y, G, SC	11-5/8	11-1/8	4	20 lbs.	12	15	6	40170 (7)	24
30128	R, B, Y, G, SC	17-7/8	4-1/8	4	15 lbs.	12	8	3	40120 (7)	24
30138	R, B, Y, G, SC	17-7/8	6-5/8	4	20 lbs.	12	15	6	40130 (7)	24
30158	R, B, Y, G, SC	17-7/8	8-3/8	4	20 lbs.	12	15	6	40150 (7)	24
30178	R, B, Y, G, SC	17-7/8	11-1/8	4	20 lbs.	12	25	12	40170 (7)	24
30124	R, B, Y, G, SC	23-5/8	4-1/8	4	20 lbs.	12	11	4	40120 (7)	24
30164	R, B, Y, G, SC	23-5/8	6-5/8	4	20 lbs.	6	21	8	40130 (7)	24
30184	R, B, Y, G, SC	23-5/8	8-3/8	4	20 lbs.	6	25	8	40150 (7)	24
30174	R, B, Y, G, SC	23-5/8	11-1/8	4	20 lbs.	6	35	16	40170 (7)	24

Other colors available with minimum order. Order in carton quantities. () = Max. # of dividers per bin.



AWS244830174RED
4" Shelf Bin Wire System

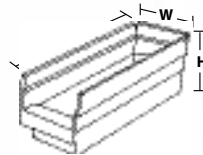

4" Shelf Bin Wire Systems			Shelf Dimensions (In.)			Quantity	
Model No.	Description	Available Colors	D	L	H	# of Bins	Shelves
AWS143630120	Wire Shelving w/ 30120 Bins	R, B, Y, G, SC	14	36	74	96	12
AWS143630130	Wire Shelving w/ 30130 Bins	R, B, Y, G, SC	14	36	74	60	12
AWS143630150	Wire Shelving w/ 30150 Bins	R, B, Y, G, SC	14	36	74	48	12
AWS143630170	Wire Shelving w/ 30170 Bins	R, B, Y, G, SC	14	36	74	36	12
AWS183630128	Wire Shelving w/ 30128 Bins	R, B, Y, G, SC	18	36	74	96	12
AWS183630138	Wire Shelving w/ 30138 Bins	R, B, Y, G, SC	18	36	74	60	12
AWS183630158	Wire Shelving w/ 30158 Bins	R, B, Y, G, SC	18	36	74	48	12
AWS183630178	Wire Shelving w/ 30178 Bins	R, B, Y, G, SC	18	36	74	36	12
AWS244830124	Wire Shelving w/ 30124 Bins	R, B, Y, G, SC	24	48	74	120	12
AWS244830164	Wire Shelving w/ 30164 Bins	R, B, Y, G, SC	24	48	74	66	12
AWS244830184	Wire Shelving w/ 30184 Bins	R, B, Y, G, SC	24	48	74	60	12
AWS244830174	Wire Shelving w/ 30174 Bins	R, B, Y, G, SC	24	48	74	48	12

*Other colors available with minimum order. Order in carton quantities.

6" Shelf Bins

- 6" tall bins expand your storage capacity up to 85% over traditional 4" bins.
- Superior, durable construction compared to corrugated bins.
- Width dividers keep items neatly separated.
- Rolled ridge for added strength when filled to maximum capacity.
- Works with 12", 18" and 24" deep shelving.
- Multiple color and sizes available.



30048RED

30094BLUE



30098SCLAR



Black width dividers available for all sizes.



Large handle makes bins easy to carry.



40410 Label holder holds oversized labels or bar-codes.



Large label area on front of bin.



30014RED



30040YELLOW

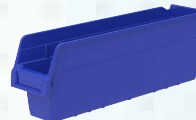

30048BLUE



30080RED



30084RED



30090BLUE

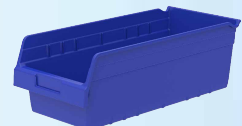

30088BLUE



30094YELLOW



30098RED

6" Shelf Bins		Outside Dimensions (In.)			Capacity/Quantity		Accessories	
Model No.	Available Colors	L	W	H	Cubic Inches	Ctn. Qty.	Black Width Dividers*	Divider Pkg. Qty.
30040	R, B, SC	11-5/8	4-1/8	6	175	16	40020 (7)	12
30090	R, B, SC	11-5/8	6-5/8	6	310	10	40030 (7)	12
30080	R, B, SC	11-5/8	8-3/8	6	398	8	40040 (7)	12
30048	R, B, SC	17-7/8	4-1/8	6	280	8	40020 (7)	12
30098	R, B, Y, SC	17-7/8	6-5/8	6	505	10	40030 (7)	12
30088	R, B, SC	17-7/8	8-3/8	6	648	8	40040 (7)	12
30094	R, B, SC	23-5/8	6-5/8	6	686	10	40030 (7)	12
30084	R, B, SC	23-5/8	8-3/8	6	935	6	40040 (7)	12
30014	R, B, SC	23-5/8	11-1/8	6	1303	6	-	12

*Other colors available with minimum order. Order in carton quantities. * () = Max. # of divider slots per bin.



AWS183630098YELLOW
6" Shelf Bin Wire System

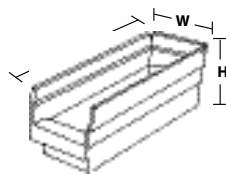

6" Shelf Bin Wire Shelving Systems			Bin Dimensions (In.)			Shelf Dimensions (In.)			Quantity	
Model No.	Description	Available Colors	L	W	H	D	L	H	Bins	Shelves
AWS183630098	Wire Shelving w/ 30098 Bins	R, B, Y, SC	17-7/8	6-5/8	6	18	36	74	40	9

*Other colors available with minimum order. Order in carton quantities.

Stack and Store Bins

- Eliminate corrugated containers from storage areas.
- Wide hopper front for easy access.
- Same size bins can be stacked on one another, on flooring or shelving.
- Stacking bins are ideal for large, bulky items.
- Large front surface for easy labeling.



Large comfort grip handles for easy lifting.



Side ribs add reinforcement for stacking stability.



Hopper front for easy access.



13017SCLAR



13018BLUE

13014BLUE



13018BLUE



AWS1836SNSGREY
Stack and Store Bin Wire System

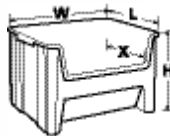

Stack and Store Bins		Outside Dimensions (In.)			Capacity/Quantity				
Model No.	Available Colors	L	W	H	Cu. Ft.	Gal	Lbs.	Stacking Height	Ctn. Qty.
13014	Blue, Grey, Clear	17-1/2	10-7/8	12-1/2	.98	7.4	75	3	4
13017	Blue, Grey, Clear	15-1/4	19-7/8	12-7/16	1.7	12.7	75	3	3
13018	Blue, Grey, Clear	17-1/2	16-1/2	12-1/2	1.6	12	75	3	2

*Other colors available with minimum order. Order in carton quantities.

Stack and Store Wire Systems		Shelf Dimensions (In.)			Quantity	
Model No.	Description	D	L	H	# of Bins	Shelves
AWS184813017	Wire Shelving w/ 13017 Bins	18	48	74	9	5
AWS183613014	Wire Shelving w/ 13014 Bins	18	36	74	12	5
AWS183613018	Wire Shelving w/ 13018 Bins	18	36	74	8	5
AWS1836SNS	Wire Shelving w/ 13014 & 13018 Bins	18	36	74	8 / 6	5

*Specify bin color when ordering.

1800 Series Bins

- Storage system for heavy, bulky items.
- Strong, durable, molded of industrial grade polymers.
- Stackable with reinforcing ribs to prevent spreading under heavy loads.
- Front and back finger grips for easy handling.
- One black width divider included per bin.



30348BEIGE



Removable divider for increased storage flexibility



Large front label area for content identification



Curved-bottom hopper front for easy content access



AWS2460M30358
1800 Series Shelf Bin
Mobile Wire System

1800 Series Bin Model No.	Outside Dimensions (In.)			Specifications			
	L	W	H	Ctn. Qty.	Dividers	Pkg. Qty.	Capacity (Lbs.)
30348BEIGE	20-1/2	8-1/4	7	6	40348 (3)	6	60
30358BEIGE	20-1/2	11	7	6	40358 (3)	6	75

*Order in carton quantities.

1800 Series Shelf Bin Wire Systems		Shelf Dimensions (In.)			Quantity	
Model No.	Description	D	L	H	# Of Bins	Shelves
AWS2460M30358	Mobile Wire Shelving w/ 30358 Bins	24	60	68	30	6

*Bins are available in Beige. Order in carton quantities.

High Visibility Shelf Bins

- Large hopped front for maximum visibility of contents.
- Works with standard steel and wire shelving or with gravity flow racking.
- 030-600 and 030-605 can securely stack for maximum space utilization.
- 030-550 is ideal for long items.

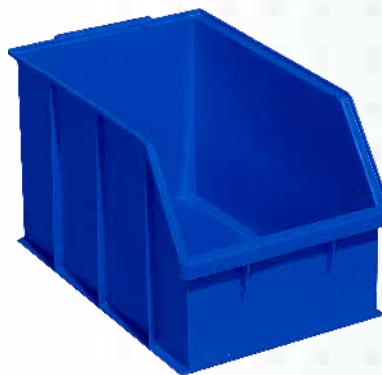

030-600BLUE



030-550BLUE



030-605BLUE

High Visibility Shelf Bins		Outside Dimensions (In.)			Capacity/Qty.	
Model No.	Available Colors	L	W	H	Weight Capacity (lbs)	Tare Weight (lbs)
030-550	Blue	24-1/4	6	5-3/4	20	2.50
030-600	Blue	18	9-3/8	10	50	2.67
030-605	Blue	16	16	8-3/16	50	2.30

*Other colors available with minimum order. Order in carton quantities.

Super-Size Bins

- Perfect for organizing and protecting large or bulky items.
- Heavy-duty bins stack securely on top of each other or sit on shelving.
- Molded of industrial-grade polymers.
- Window inserts and dividers available for expanded storage options.
- Available multiple colors and sizes.



30286SCLAR



30287RED

Super-Size Bins		Outside Dimensions (In.)			Capacity/Quantity			Accessories			
Model No.	Available Colors	L	W	H	Max. Cap. Per Bin	Stacking Cap. / = Qty. Stacked	Ctn. Qty.	Width Dividers*	Length Dividers*	Divider Pkg. Qty.	
30280	R, B, Y, SC, GY	20	12-3/8	6	200 lbs.	40 lb./10	4	–	40280 (3)	–	2
30281	R, B, Y, SC, GY	20	12-3/8	8	200 lbs.	50 lb./7	3	–	40281 (3)	–	3
30282	R, B, Y, SC, GY	20	12-3/8	12	200 lbs.	60 lb./5	2	–	40282 (3)	–	1
30283	R, B, Y, SC, GY	20	18-3/8	12	300 lbs.	150 lb./5	1	–	40282 (3)	–	1
30284	R, B, Y, SC, GY	23-7/8	8-1/4	7	200 lbs.	150 lb./5	4	41284 (2)	40286 (1)	2	4
30286	R, B, Y, SC, GY	23-7/8	11	7	200 lbs.	150 lb./5	4	41286 (2)	40286 (3)	2	4
30287	R, B, Y, SC, GY	23-7/8	11	10	300 lbs.	150 lb./5	4	41287 (2)	40287 (3)	6	6
30288	R, B, Y, SC, GY	23-7/8	16-1/2	11	300 lbs.	150 lb./5	1	41288 (2)	40287 (3)	6	6
30289	R, B, Y, SC, GY	23-7/8	18-1/4	12	300 lbs.	150 lb./5	1	41289 (2)	–	2	–
30290	R, B, Y, SC, GY	29-1/4	18-3/8	12	300 lbs.	150 lb./5	1	–	40290 (3)	–	1
30292	R, B, Y, SC, GY	29-7/8	11	10	300 lbs.	150 lb./5	4	41287 (2)	40292 (3)	6	6
30293	R, B, Y, SC, GY	29-7/8	16-1/2	11	300 lbs.	150 lb./5	1	41288 (2)	40292 (3)	6	6

*Other colors available with minimum order. Order in carton quantities. * () = Max. # of divider slots per bin.



Optional dividers keep parts separated widthwise or lengthwise.



Easy to carry with large handle molded onto back of bin



AWS184830282YELLOW
Super-Size Bin Wire System

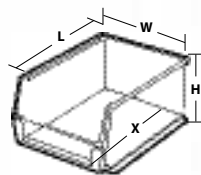

Super-Size Bin Wire Systems		Shelf Dimensions (In.)			Quantity	
Model No.	Description	D	L	H	# of Bins	Shelves
AWS184830280	Wire Shelving w/ 30280 Bins	18	48	74	24	9
AWS184830281	Wire Shelving w/ 30281 Bins	18	48	74	18	7
AWS184830282	Wire Shelving w/ 30282 Bins	18	48	74	12	5
AWS184830283	Wire Shelving w/ 30283 Bins	18	48	74	8	5
AWS1848SAB	Wire Shelving w/ 30280, 30281, 30282, 30283 Bins	18	48	74	4 / 3 / 4 / 4	6
AWS24360284	Wire Shelving w/ 30284 Bins	24	36	74	28	8
AWS24360287	Wire Shelving w/ 30287 Bins	24	36	74	16†	6
AWS24360288	Wire Shelving w/ 30288 Bins	24	36	74	12	3
AWS24360SAB	Wire Shelving w/ 30287 & 30288 Bins	24	36	74	12 / 6	3
AWS24361288	Wire Shelving w/ 30288 Bins	24	36	63	10	3

*Other colors available with minimum order. Order in carton quantities.

Drawer Bins

- Offered in 12", 18" or 24" depths to work with shelving.
- Easy to label and color code inventory for quick identification of supplies.
- Wide front handle for easy gripping.
- Drawers fit securely in cabinets or enclosed steel shelving for dust-free storage.
- Dividers available to keep contents neatly separated in drawers.
- Available in multiple colors and sizes.



31168CRY

Drawer Bins		Outside Dimensions (In.)			Capacity/Qty.		Accessories	
Model No.	Available Colors	L	W	H	Weight Capacity	Ctn. Qty.	Dividers	Pkg. Qty
31142	Red, Blue, Yellow, Grey, Clear	11-5/8	3-3/4	4-5/8	15 lbs.	6	41440	6
31148	Red, Blue, Yellow, Grey, Clear	17-5/8	3-3/4	4-5/8	20 lbs.	6	41440	6
31162	Red, Blue, Yellow, Grey, Clear	11-5/8	5-9/16	4-5/8	20 lbs.	6	41460	6
31168	Red, Blue, Yellow, Grey, Clear	17-5/8	5-9/16	4-5/8	25 lbs.	6	41460	6
31182	Red, Blue, Yellow, Grey, Clear	11-5/8	8-3/8	4-5/8	20 lbs.	4	41480	6
31188	Red, Blue, Yellow, Grey, Clear	17-5/8	8-3/8	4-5/8	25 lbs.	4	41480	6
31112	Red, Blue, Yellow, Grey, Clear	11-5/8	11-1/8	4-5/8	25 lbs.	4	41410	8
31118	Red, Blue, Yellow, Grey, Clear	17-5/8	11-1/8	4-5/8	25 lbs.	4	41410	8

*Other colors available with minimum order. Order in carton quantities.



Backstop tab ensures bins tilt out without falling



Large label area and wide handle

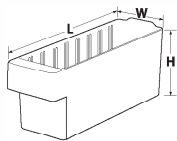

System Bins

- Designed to fit on a 36" wide steel or wire shelving, cabinets and drawers.
- Sturdy interior double-wall construction.
- Bins nest when empty to conserve space.
- Available in 12" or 18" depths in multiple colors.
- Smooth surfaces are easy to fill, handle, and keep clean.



30318BLUE



System Bins		Dimensions (In.)			Bin Compartment Dimensions (In.)*			Ctn. Qty.
Model No.	Description	L	W	H	L	W	H	
30312	12" System Bin	12	33	5	10-3/8	3-5/8	4-15/16	5
30318	18" System Bin	18	33	5	16-3/8	3-5/8	4-15/16	5

*Other colors available with minimum order. Order in carton quantities.

*Bottom inside dimension per compartment.

Indicator Two-Tone Inventory Control Bin

- Bright orange or red trigger color shows low stock levels.
- Innovative double-hopper bins can be filled or picked from both sides.
- Large label area on both sides of the bin.
- Rolled ridge provides added strength and durability.
- Width dividers used to separate reserve stock.
- Prevents stock outs with visual recognition when supplies need to be replenished.
- Low cost alternative to high end inventory control systems.

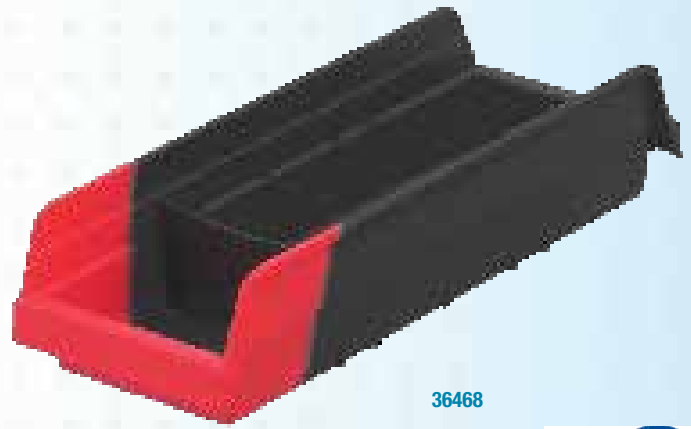

36468



Width dividers available for all sizes (sold separately)



Stock | Pick | Flip | Replenish

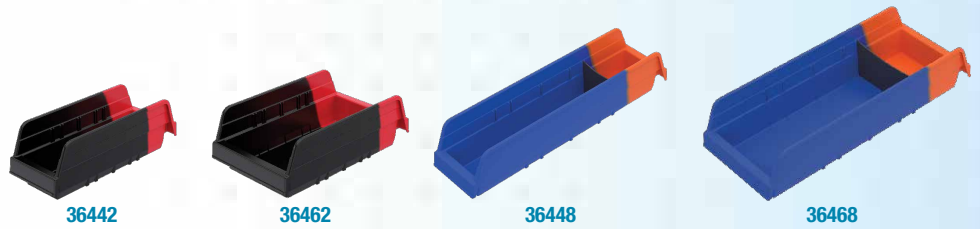
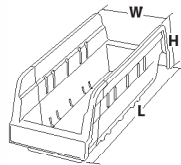

Indicator Bins		Outside Dimensions (In.)			Inside Dimensions (In.)			Accessories		
Model No.	Description	L	W	H	L	W	H	Bin Ctn. Qty.	Dividers*	Divider Pkg. Qty.
36442BLUE	Blue/Orange Bin	11-5/8	4-1/4	4	9-7/8	2-7/8	3-7/8	24	40120	24
36442BLKRED	Black/Red Bin	11-5/8	4-1/4	4	9-7/8	2-7/8	3-7/8	24	40120	24
36448BLUE	Blue/Orange Bin	17-7/8	4-1/8	4	16-1/8	2-3/4	3-7/8	12	40442	12
36448BLKRED	Black/Red Bin	17-7/8	4-1/8	4	16-1/8	2-3/4	3-7/8	12	40442	12
36462BLUE	Blue/Orange Bin	11-5/8	6-3/4	4	9-7/8	5-3/8	3-7/8	12	40130	24
36462BLKRED	Black/Red Bin	11-5/8	6-3/4	4	9-7/8	5-3/8	3-7/8	12	40130	24
36468BLUE	Blue/Orange Bin	17-7/8	6-5/8	4	16-1/8	5-1/4	3-7/8	12	40462	12
36468BLKRED	Black/Red Bin	17-7/8	6-5/8	4	16-1/8	5-1/4	3-7/8	12	40462	12

*Dividers sold separately. Order in carton quantities.

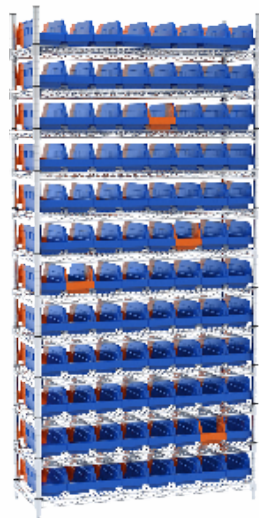

AWS143636442B

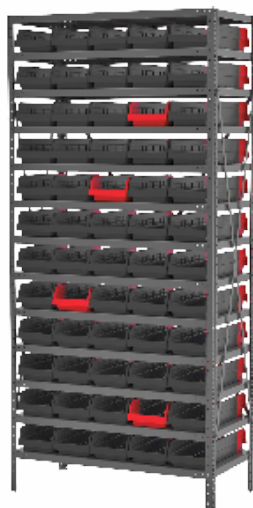

AS187936468BK

Indicator Wire System			
Model No.	Description	Color	Bin Qty.
AWS143636442B	Shelving w/ 36442 Bins	Blue/Orange	96
AWS143636462B	Shelving w/ 36462 Bins	Blue/Orange	60
AWS183636448B	Shelving w/ 36448 Bins	Blue/Orange	96
AWS183636468B	Shelving w/ 36468 Bins	Blue/Orange	60
AWS143636442BK	Shelving w/ 36442 Bins	Black/Red	96
AWS143636462BK	Shelving w/ 36462 Bins	Black/Red	60
AWS183636448BK	Shelving w/ 36448 Bins	Black/Red	96
AWS183636468BK	Shelving w/ 36468 Bins	Black/Red	60

*Order in carton quantities

Indicator Steel System			
Model No.	Description	Color	Bin Qty.
AS127936442B	Shelving w/ 36442 Bins	Blue/Orange	96
AS127936462B	Shelving w/ 36462 Bins	Blue/Orange	60
AS187936448B	Shelving w/ 36448 Bins	Blue/Orange	96
AS187936468B	Shelving w/ 36468 Bins	Blue/Orange	60
AS127936442BK	Shelving w/ 36442 Bins	Black/Red	96
AS127936462BK	Shelving w/ 36462 Bins	Black/Red	60
AS187936448BK	Shelving w/ 36448 Bins	Black/Red	96
AS187936468BK	Shelving w/ 36468 Bins	Black/Red	60

*Order in carton quantities

InSight® Bins

- Provide maximum visibility to users in a sleek, modern bin design.
- Can stack, sit on shelving, or hang on panels, rails or racks.
- Optional lids protect contents from dust and will stack with lids in place.
- No-tip feature when bins are stacked.
- Large label area for part identification and bar-code scanning.
- Bins are made of high-impact polycarbonate and are autoclavable up to 250° F.



305A3



Bins stack with lids in place



Lids protect bin contents from dust

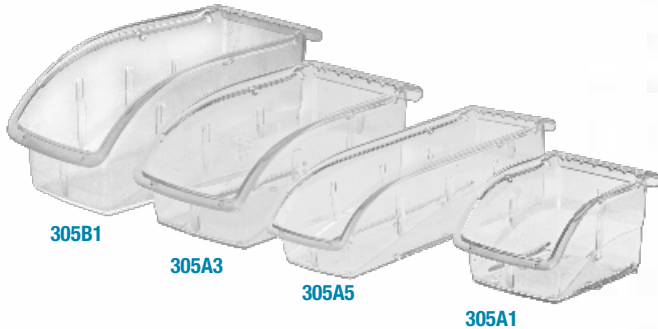

305B1

305A3

305A5

305A1



305A3



InSight Bins Model No.	Outside Dimensions (In.)			Capacity/Quantity		Accessories	
	L	W	H	Capacity (lbs.)	Bin Ctn. Qty.	Lid	Lid Pkg Qty.
305A1	5-3/8	4-1/8	3-1/4	10	16	305A2	16
305A3	7-3/8	4-1/8	3-1/4	10	16	305A4	16
305A5	10-7/8	4-1/8	3-1/4	15	12	305A6	12
305B1	10-7/8	5-1/2	5-1/4	25	12	305B2	12

*Order in carton quantities.



Louvered panel 30618 shown with 305B1 bins



Louvered panel 30636 shown with 305A3 bins

Wire Mesh Hanging Bins

- Provide maximum visibility to users with the innovative mesh design and nickel-chrome finish.
- Mesh hanging bins prevents dust and dirt accumulation.
- Ultra strong design allows for superior hang capacity.
- Open hopper allows for easy picking while allowing visual access to stored contents.

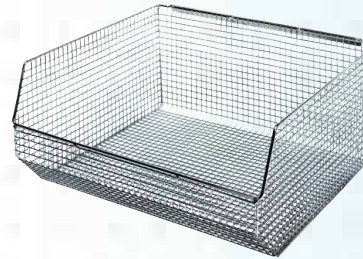

QMB550C



QMB530C



QMB530C with optional HMB530/535C open



QMB510C with optional HMB510C closed

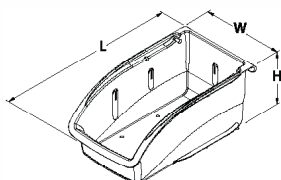

Wire Mesh Hanging Bins		Outside Dimensions (In.)			Inside Dimensions (In.)			Accessories		
Model No.	Color	L	W	H	L	W	H	Bin Ctn. Qty.	Dividers*	Side Hanger*
QMB510C	Chrome	5-1/4	4-1/4	3	4-3/4	4	2-7/8	20	DMB510C	HMB510C
QMB520C	Chrome	7-1/4	4-1/4	3	6-3/4	4	2-7/8	20	DMB520C	HMB520C
QMB524C	Chrome	11	4-3/4	4	10-3/8	4-1/4	3-3/4	10	DMB524C	HMB530/535C
QMB530C	Chrome	10-3/4	5-1/2	5	10-1/4	5-1/2	4-3/4	10	DMB530/535C	HMB530/535C
QMB534C	Chrome	15	6	5	14-1/4	5-5/8	4-3/4	10	DMB534C	HMB540/550C
QMB535C	Chrome	10-3/4	11	5	10-1/4	10-3/4	4-3/4	10	DMB530/535C	HMB530/535C
QMB539C	Chrome	10-1/2	8	7	10	7-1/2	6-3/4	10	DMB539C	HMB539C
QMB540C	Chrome	14-1/2	8	7	14	7-1/2	6-3/4	10	DMB540/550C	HMB540/550C
QMB550C	Chrome	14-1/2	16-1/4	7	14	15-3/4	6-3/4	5	DMB540/550C	HMB540/550C
QMB560C	Chrome	18-1/2	11	10-1/4	18	10-5/8	10	5	DMB560/570C	HMB560/570C
QMB565C	Chrome	17-3/4	8-1/8	9	17-1/8	7-3/4	8-3/4	5	DMB565C	HMB565C
QMB570C	Chrome	18-1/2	17-1/8	11-1/4	18	16-5/8	11	5	DMB560/570C	HMB560/570C

*Dividers sold separately. Order in carton quantities. Side hangers sold as pairs.

Tilt View Bins

- Space-saving system will improve organization and efficiency by keeping supplies in view.
- Can be used on a desk, attached to steel rails, frames or louvered panels, and are wall mountable.
- Cabinets are made of high-impact polystyrene.
- Bins made of polystyrene (GPS).
- Molded-in label holder (card stock labels included).
- 06702 slides apart to form two separate bins.



06704



Bins stack securely



Attractive bins blend into any setting



06702 can be separated to single bins



06702



06703



06704

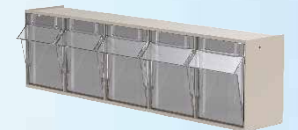

06705



06706

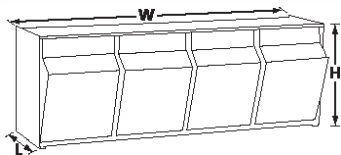

Tilt View Bins		Dimensions (In.)			Capacity/Qty.	
Model No.	Description	L	W	H	Ctn. Qty.	Capacity Lbs.
06702	2-Bin Tilt View	12-5/16	23-5/8	14	1	30
06703	3-Bin Tilt View	7-7/8	23-5/8	9-7/16	1	30
06704	4-Bin Tilt View	6-3/4	23-5/8	8-3/16	1	25
06705	5-Bin Tilt View	5-3/8	23-5/8	6-1/2	1	20
06706	6-Bin Tilt View	3-3/4	23-5/8	4-1/2	1	15



06704 Stacked and labeled

Tote Caddy

- Compact, hand-held supply caddy.
- Functional, deep compartments hold loose items, medical and cleaning supplies or tools for easy transport.
- The perfect phlebotomy caddy!
- Molded of heavy-duty, industrial-grade polymers for lasting durability.



09185BLUE

Tote Caddy		Dimensions (In.)			Ctn. Qty.
Model No.	Description	L	W	H	
09185BLUE	Blue Tote Caddy	13-7/8	18-3/8	9	6

*Order in carton quantities.

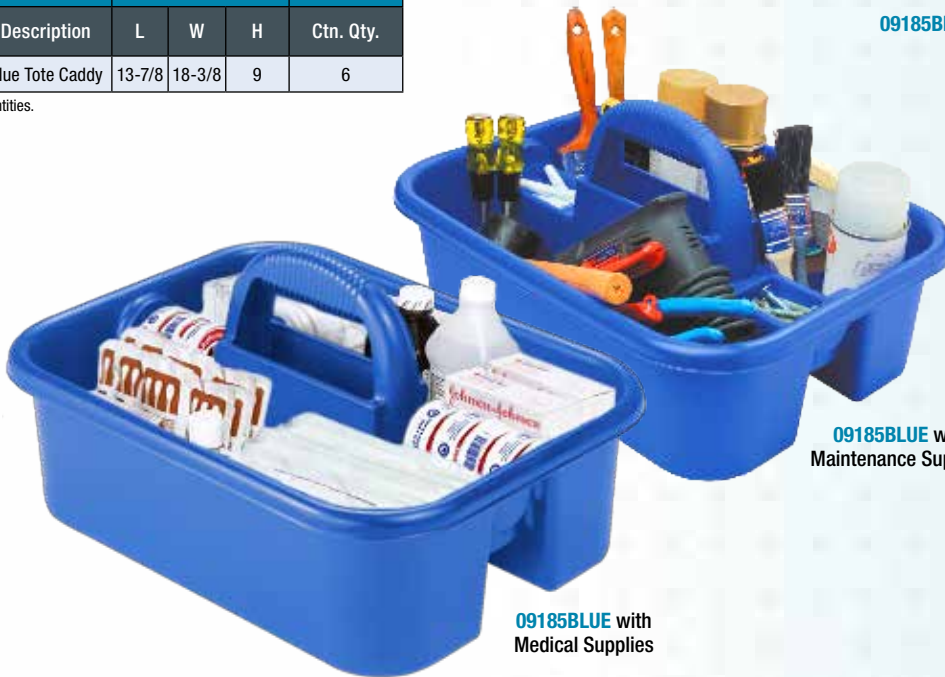

09185BLUE with Maintenance Supplies

09185BLUE with Medical Supplies

Supply Box

- Great as a supply transport tote or emergency box.
- Removable tray keeps smaller items quickly accessible.
- Molded of heavy-duty, industrial-grade polymers for lasting durability.
- Oversized padlock eye accepts a variety of padlocks or zip ties in order to make the box tamper-evident.
- Available in Clear



09514CFT

Supply Box		Dimensions (In.)			Ctn. Qty.
Model No.	Description	L	W	H	
09514CFT	Clear Supply Box	14	8-1/8	8-1/8	3

*Order in carton quantities.

Louvered Panels, Floor Racks & Bench Racks

- Louvered Panels securely support hanging and stacking bins, InSight® bins, or steel cabinets (sold separately).
- Heavy-duty 16-gauge, cold-rolled steel for strength and durability.
- Wall-mounted units keep items out of the way, off the floor and off the work table.
- Floor racks can be placed near work areas to improve productivity.
- Mobile kits mobilize racks; easily relocate supplies without unloading and reloading bins.



98600
Bench Rack

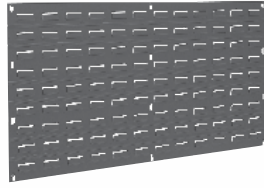

30636BEIGE
Louvered Wall Panel



30632
Single Row Louvered Panel

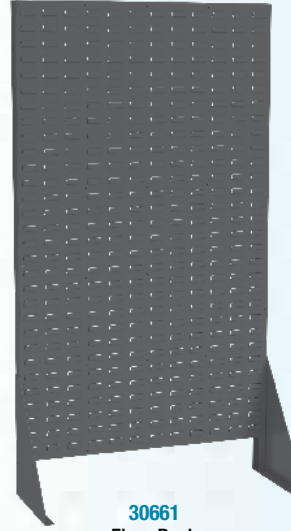

30661
Floor Rack



Louvered Wall Panel & **30255**
Hanging and Stacking Bins

Louvered Hanging Systems		Dimensions (In.)			Rack Wt. Cap. (lbs)	Bin Quantity to Fit Louvered Hanging System														
Model No.	Description	L	W	H		30210	30220	30224	30230	30234	30235	30237	30239	30240	30250	30255	30260	30265	30270	30320
30618	Louvered Wall Panel	18	5/16	19	160	16	16	12	9	9	3	6	4	4	2	3	1	2	1	-
30632	Single Row Louvered Panel	2	31-15/16	5/16	80	7	7	7	5	5	2	5	3	3	1	1	2	3	1	-
30636	Louvered Wall Panel	35-3/4	5/16	19	160	32	32	24	18	18	9	15	8	8	4	6	3	4	2	3
30161	Louvered Wall Panel	36	5/16	61	1000	120	120	80	60	60	30	50	28	28	14	20	15	24	10	10
30118	Louvered Wall Panel	18	5/16	61	500	60	60	40	30	30	10	20	14	14	7	10	5	12	5	-
30661	Single-Sided Rivet Floor Rack	36-3/16	13-1/2	66-3/8	500	120	120	80	60	60	30	50	28	28	14	20	15	24	10	10
30676	Double-Sided Rivet Floor Rack	36-3/16	25	66-3/8	1000	240	240	160	120	120	60	100	56	56	28	40	30	48	20	20
98600	Bench Rack	27-15/16	8-9/16	19-9/16	120	30	30	18	12	12	6	12	6	6	2	3	2	6	-	-
LVDMOBILE	Gray Mobile Kit for 30676	-	-	-	1500	-	-	-	-	-	-	-	-	-	-	-	-	-	-	-
30661DOLLY	Floor Rack Dolly for 30661	37	24	6	500	-	-	-	-	-	-	-	-	-	-	-	-	-	-	-



30661 & 30661DOLLY with Hanging and Stacking Bins



30661DOLLY

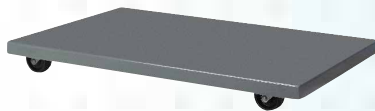

LVDMOBILE



30653 with Hanging and Stacking Bins

Rail Bin Hanging Systems

- Steel Rail Racks securely support hanging and stacking bins, InSight® bins, or steel cabinets (sold separately).
- Heavy-duty steel for strength and durability.
- Wall-mounted units keep items out of the way, off the floor and off the work table.
- Floor racks can be placed near work areas to improve productivity.
- Mobile kit mobilize racks; easily relocate supplies without unloading and reloading bins.

HOW TO CHOOSE: Louvers vs. Rails

Louvers: Steel panels with rows of punched louvers. More storage capacity, greater selection of styles. Panels can be attached to the wall, freeing floor space. Rivet racks come with the panels already riveted to the frame.

Rails: Constructed of individual steel rails that span between uprights. Weigh less than louvered panels, more economical, small footprint, easy to remove bins from rails.



30016 Rail Rack with 30220SCLAR Bins



30016 Rail Rack with 30235YELLOW Bins



30812 Mobile Rack Cart with 30230YELLOW Bins

Rail Bin Hanging Systems		Dimensions (In.)			Rack Wt. Cap. (lbs)	Bin Quantity to Fit Louvered Hanging System													
Model No.	Description	L	W	H		30210	30220	30224	30230	30234	30235	30237	30239	30240	30250	30255	30260	30265	30270
30008	Single Sided Rail Rack	36	14-1/8	53	250	96	96	64	48	48	24	40	24	24	12	16	12	16	8
30016	Double Sided Rail Rack	36	20	53	500	192	192	128	96	96	48	80	48	48	24	32	24	32	16
30148	Wall Mount Rail	47-13/16	5-8	3	110	11	11	11	8	8	4	8	5	5	2	2	4	5	2
30812	Mobile Rail Bin Cart	38-1/2	24	36-1/2	250	96	96	64	48	48	24	40	24	24	12	16	12	16	8
30424	Mobile Kit - Casters and Handle	-	-	-	500	-	-	-	-	-	-	-	-	-	-	-	-	-	-
98400	Suspension Straps (Set of 2)*	-	-	-	-	-	-	-	-	-	-	-	-	-	-	-	-	-	-

*Can be assembled as a 12 or 16 rail rack.

*98400 suspension straps required for hanging 19-Series Cabinets. Two straps needed to secure cabinet to rack.



30016 Rail Rack with 30240SCLAR Bins



30148 Single Row Steel Rail



30424 Mobile Kit for Rail Rack



30424 Mobile Kit with Rail Rack

19-Series Steel Storage Cabinets

- Great for organizing small items such as dental instruments or lab supplies.
- Helps to keep inventory accurate and dust-free.
- Clear windows provide easy visibility of contents.
- Stackable, wall mountable or can be used on 36" wide shelving.
- Galvannealed steel frame with full steel shelf under each row of drawers.

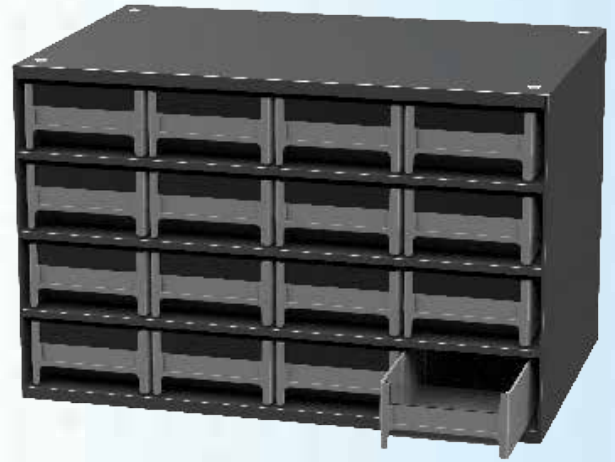

19228



19320



19416

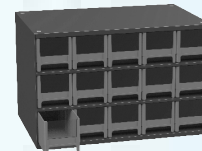

19715

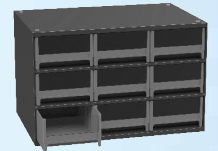

19909

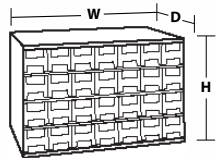

19-Series Heavy-Duty Steel Cabinets			Drawer Dimensions (In.)		
Model No.	Description	Drawers Per Cabinet	W	H	D
19228	Gray Steel Storage Cabinet	28	2-3/16	2-1/16	10-9/16
19320	Gray Steel Storage Cabinet	20	3-3/16	2-1/16	10-9/16
19416	Gray Steel Storage Cabinet	16	4	2-1/8	10-9/16
19715	Gray Steel Storage Cabinet	15	3-3/16	3-1/16	10-9/16
19909	Gray Steel Storage Cabinet	9	5-3/16	3-1/16	10-9/16

Steel Pick Racks

- Works with shelf bins, indicator bins, drawer bins, and system bins.
- Angled shelves keep small items at the front of the bin.

CUSTOM STORAGE SOLUTIONS

Customize Pick Racks with Shelf Bins, Indicator® Bins, Drawer Bins, or System Bins.



APRD with 30120YELLOW shelf bins and APRDMOBILE

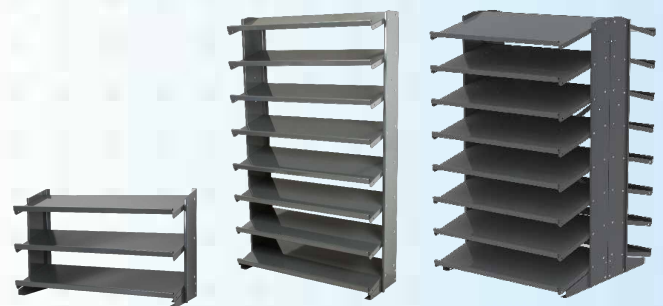

APRBENCH

APRS

APRD18

Steel Pick Rack			Shelf Dimensions (in.)			
Model No.	Description	Wt. Capacity (Lbs.)	Caster	D	L	H
APRS	Single-Sided Pick Rack (no bins)	400	–	12-1/8	35-5/8	6-7/16
APRD	Double-Sided Pick Rack (no bins)	800	–	12-1/8	35-5/8	6-7/16
APRDMOBILE	Mobile Kit (Handle & Dolly) for Double-Sided Pick Rack	500	4" x 1½" Polyolefin	–	–	–
APRS18	Single-Sided Pick Rack (no bins)	900*	–	18-1/8	35-5/8	6-7/16
APRD18	Double-Sided Pick Rack (no bins)	1800**	–	18-1/8	35-5/8	6-7/16
APRD18MOBILE	Mobile Kit (Handle & Dolly) for Double-Sided Pick Rack	1800	5" x 2" Phenolic	–	–	–
APRBENCH	Bench Pick Rack, No Bins	–	–	–	–	–

* When anchored to wall and floor. ** When anchored to floor.

Storage and Security Bin Cabinets

- Lexan™ door panels allow easy viewing, even when cabinet is locked.
- Keyed handle with 3-point locking system for total security, preventing damage or theft of sensitive supplies.
- Purchase as complete kit using hanging and stacking bins or Tilt View bins.
- All-welded 16-gauge steel construction.



AC3618QV240YELLOW



AC3618QV

AC3618QV250



Keyed handle
(2 keys included)

Quick-View Security Bin Cabinet		Outside Dimensions (In.)			Bin Dimensions (In.)				
Model No.	Description	Width	Depth	Height	Bin Model No.	L	W	H	Qty. of Bins
AC3618QV240	Beige Cabinet w/ Quick View Doors, Louvered Back, with H&S Bins	36	18	78	30240	14-3/4	8-1/4	7	36
AC3618QV250	Beige Cabinet w/ Quick View Doors, Louvered Back, with H&S Bins	36	18	78	30250	14-3/4	16-1/2	7	18
AC3618QV	Beige Cabinet w/ Quick View Doors	-	-	-	-	-	-	-	-

*Other colors available with minimum order. Order in carton quantities.

- Heavy Duty All-Welded Bin Storage Cabinets.
- Available in 18" Depths and 24" Depths.
- Optional steel shelves can be adjusted to various heights.
- Compatible with hanging and stacking bins (See page 7).

CUSTOM STORAGE SOLUTIONS

Pair Storage Cabinets with Hanging and Stacking Bins, Shelves and Shelf Bins, Indicator® Bins, Drawer Bins, or System Bins.



3624-BDLP with hanging and stacking bins



3618-BLP



3624-BDLP with hanging and stacking bins and three 3624SHELF

Heavy Duty All Welded Steel Storage Cabinets		Dimensions (In.)			
Model No.	Description	Width	Depth	Height	Capacity (Lbs.)
3618-BLP	All Welded Steel Cabinet, Louvers Back Only	36	18	72	-
3624-BDLP	All Welded Steel Cabinet, Louvers Back and Door	36	24	72	-
3618SHELF	Heavy Duty Steel Shelf	35-1/2	16-3/8	-	900 Lbs.
3624SHELF	Heavy Duty Steel Shelf	35-1/2	21-3/8	-	900 Lbs.

*Other sizes, customizations, colors available upon request with minimum order. Bins not included.

Wire Shelving Starter Units

- Meet compliance regulations by getting your supplies up off the floor with wire shelving units.
- Heavy-duty wire shelving units prevent dust accumulation and improve visibility of stored items.
- Assembles in minutes, no tools required.
- Shelf Weight Capacity: 800 lbs. for shelf lengths up to 48", 600 lbs. for shelf lengths over 48".
- Units Include: 4 - Chrome Wire Shelves with Quick-Adjust Post Sleeves, 4 - Posts with Leveling Feet, 1 - 8 pack of "S" Hooks for creating continuous shelving runs or 90° Angles.
- Add labels, see page 25.
- Mobile kits for high density storage available.

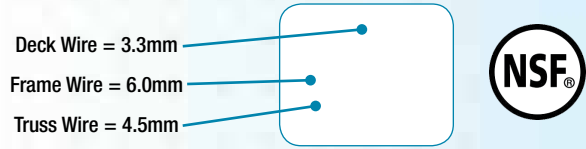

Wire Shelving Starter Units				
Model No.	Description	Post Qty.	Shelf Qty.	S-Hook Qty.
AWS541224SU	Wire Shelving 54" High 12 x 24 Starter Unit	4	4	1 - 8 Pack
AWS541236SU	Wire Shelving 54" High 12 x 36 Starter Unit	4	4	1 - 8 Pack
AWS541436SU	Wire Shelving 54" High 14 x 36 Starter Unit	4	4	1 - 8 Pack
AWS541824SU	Wire Shelving 54" High 18 x 24 Starter Unit	4	4	1 - 8 Pack
AWS541830SU	Wire Shelving 54" High 18 x 30 Starter Unit	4	4	1 - 8 Pack
AWS541836SU	Wire Shelving 54" High 18 x 36 Starter Unit	4	4	1 - 8 Pack
AWS541848SU	Wire Shelving 54" High 18 x 48 Starter Unit	4	4	1 - 8 Pack
AWS542436SU	Wire Shelving 54" High 24 x 36 Starter Unit	4	4	1 - 8 Pack
AWS542448SU	Wire Shelving 54" High 24 x 48 Starter Unit	4	4	1 - 8 Pack
AWS542460SU	Wire Shelving 54" High 24 x 60 Starter Unit	4	4	1 - 8 Pack
AWS542472SU	Wire Shelving 54" High 24 x 72 Starter Unit	4	4	1 - 8 Pack
AWS631224SU	Wire Shelving 63" High 12 x 24 Starter Unit	4	4	1 - 8 Pack
AWS631236SU	Wire Shelving 63" High 12 x 36 Starter Unit	4	4	1 - 8 Pack
AWS631436SU	Wire Shelving 63" High 14 x 36 Starter Unit	4	4	1 - 8 Pack
AWS631824SU	Wire Shelving 63" High 18 x 24 Starter Unit	4	4	1 - 8 Pack
AWS631830SU	Wire Shelving 63" High 18 x 30 Starter Unit	4	4	1 - 8 Pack
AWS631836SU	Wire Shelving 63" High 18 x 36 Starter Unit	4	4	1 - 8 Pack
AWS631848SU	Wire Shelving 63" High 18 x 48 Starter Unit	4	4	1 - 8 Pack
AWS632436SU	Wire Shelving 63" High 24 x 36 Starter Unit	4	4	1 - 8 Pack
AWS632448SU	Wire Shelving 63" High 24 x 48 Starter Unit	4	4	1 - 8 Pack
AWS632460SU	Wire Shelving 63" High 24 x 60 Starter Unit	4	4	1 - 8 Pack
AWS632472SU	Wire Shelving 63" High 24 x 72 Starter Unit	4	4	1 - 8 Pack

Wire Shelving Starter Units				
Model No.	Description	Post Qty.	Shelf Qty.	S-Hook Qty.
AWS741224SU	Wire Shelving 74" High 12 x 24 Starter Unit	4	4	1 - 8 Pack
AWS741236SU	Wire Shelving 74" High 12 x 36 Starter Unit	4	4	1 - 8 Pack
AWS741436SU	Wire Shelving 74" High 14 x 36 Starter Unit	4	4	1 - 8 Pack
AWS741824SU	Wire Shelving 74" High 18 x 24 Starter Unit	4	4	1 - 8 Pack
AWS741830SU	Wire Shelving 74" High 18 x 30 Starter Unit	4	4	1 - 8 Pack
AWS741836SU	Wire Shelving 74" High 18 x 36 Starter Unit	4	4	1 - 8 Pack
AWS741848SU	Wire Shelving 74" High 18 x 48 Starter Unit	4	4	1 - 8 Pack
AWS742436SU	Wire Shelving 74" High 24 x 36 Starter Unit	4	4	1 - 8 Pack
AWS742448SU	Wire Shelving 74" High 24 x 48 Starter Unit	4	4	1 - 8 Pack
AWS742460SU	Wire Shelving 74" High 24 x 60 Starter Unit	4	4	1 - 8 Pack
AWS742472SU	Wire Shelving 74" High 24 x 72 Starter Unit	4	4	1 - 8 Pack
AWS861224SU	Wire Shelving 86" High 12 x 24 Starter Unit	4	4	1 - 8 Pack
AWS861236SU	Wire Shelving 86" High 12 x 36 Starter Unit	4	4	1 - 8 Pack
AWS861436SU	Wire Shelving 86" High 14 x 36 Starter Unit	4	4	1 - 8 Pack
AWS861824SU	Wire Shelving 86" High 18 x 24 Starter Unit	4	4	1 - 8 Pack
AWS861830SU	Wire Shelving 86" High 18 x 30 Starter Unit	4	4	1 - 8 Pack
AWS861836SU	Wire Shelving 86" High 18 x 36 Starter Unit	4	4	1 - 8 Pack
AWS861848SU	Wire Shelving 86" High 18 x 48 Starter Unit	4	4	1 - 8 Pack
AWS862436SU	Wire Shelving 86" High 24 x 36 Starter Unit	4	4	1 - 8 Pack
AWS862448SU	Wire Shelving 86" High 24 x 48 Starter Unit	4	4	1 - 8 Pack
AWS862460SU	Wire Shelving 86" High 24 x 60 Starter Unit	4	4	1 - 8 Pack
AWS862472SU	Wire Shelving 86" High 24 x 72 Starter Unit	4	4	1 - 8 Pack

Wire Shelving Components

Order the exact size shelves, posts and custom components to fit your space requirements!

Deck Wire = 3.3mm

Frame Wire = 6.0mm

Truss Wire = 4.5mm

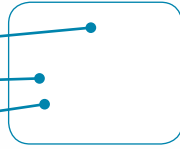

Horizontal Shelves

- NSF Certified Wire Shelves - Plastic Quick Adjust Clips included with each shelf (Replacement part: AWCLIP4PK).
- Weight Capacity (evenly distributed) per shelf: Lengths up to 48" = 800 lbs. Lengths over 48" = 600 lbs.
- Weight Capacity (evenly distributed) per stationary shelving unit = 2,000 lbs.
- Shelving can be assembled in minutes and no special tools are required

Upright Posts

- Posts include a Leveling Foot to compensate for uneven surfaces (Replacement part: AWFOOTLEVEL4PK).
- All posts include a plastic post top cap and a 3/8"-16 threaded base insert for installing feet and casters.
- Durable nickel-chrome finish.



24 x 48 x 74

Shelf Sizes

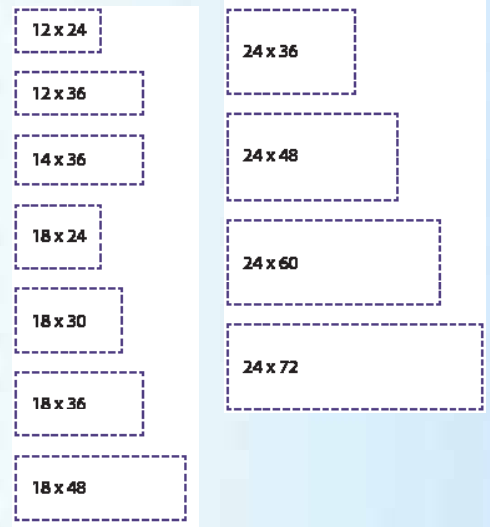

Horizontal Shelf

Wire Shelves - Chrome		
Model No.	Description	Ctn. Qty.
AWS1224SHELF	12" x 24" Horizontal Wire Shelf	4
AWS1236SHELF	12" x 36" Horizontal Wire Shelf	4
AWS1436SHELF	14" x 36" Horizontal Wire Shelf	4
AWS1824SHELF	18" x 24" Horizontal Wire Shelf	4
AWS1830SHELF	18" x 30" Horizontal Wire Shelf	4
AWS1836SHELF	18" x 36" Horizontal Wire Shelf	4
AWS1848SHELF	18" x 48" Horizontal Wire Shelf	4
AWS2436SHELF	24" x 36" Horizontal Wire Shelf	4
AWS2448SHELF	24" x 48" Horizontal Wire Shelf	4
AWS2460SHELF	24" x 60" Horizontal Wire Shelf	2
AWS2472SHELF	24" x 72" Horizontal Wire Shelf	2



Shelf Posts



Posts include Leveling Foot

Wire Shelving Posts - Chrome

Model No.	Description	Ctn. Qty.
AWP54UPRIGHT	54" Shelf Post	4
AWP63UPRIGHT	63" Shelf Post	4
AWP74UPRIGHT	74" Shelf Post	4
AWP86UPRIGHT	86" Shelf Post	4

Wire Shelving Accessories

Shelf Liner Mat

- 1mm thick clear polypropylene mat keeps small items from falling through shelves.
- Prevents dust accumulation on shelves below.

Swivel Casters

- Create mobile shelving units and carts with these swivel caster sets.
- Choose from 4" casters, 2 with brakes, 2 without, or 5" casters, all with brakes.

"S" Hooks

- Allow for continuous runs of shelving or 90° angles.
- Use two hooks per shelf.

Leveling Feet

- Levels shelving units on uneven surfaces.

Steel Feet Immobilizer

- Provides extra stability to shelving units.
- Allows shelving units to be secured to the floor.

Donut Bumper

- Slides onto bottom of upright posts.
- Add to mobile units to prevent them from damaging walls.

Quick-Adjust Clips

- For assembling shelves to posts.

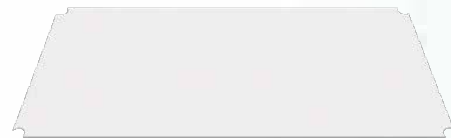
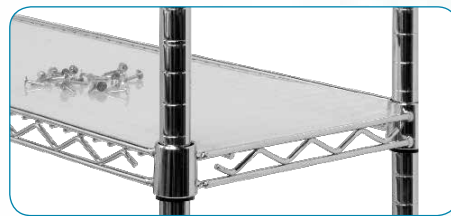
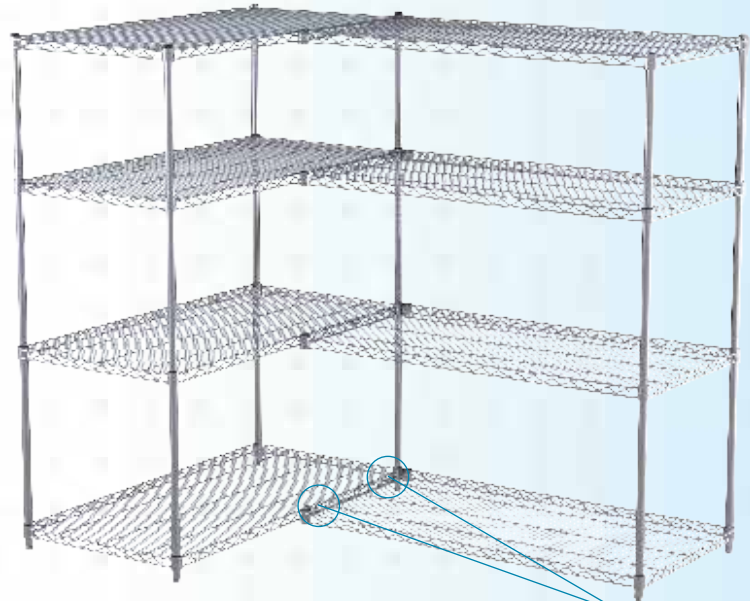

Shelf Liner Mat



"S" Hooks

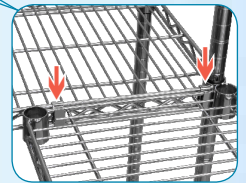

Leveling Feet



Steel Feet Immobilizer



Donut Bumper



Quick-Adjust Clips



Wire Shelving Shelf Liner Mats		
Model No.	Description	Ctn. Qty.
AW1236LINER	12" x 36" Shelf Liner	4
AW1836LINER	18" x 36" Shelf Liner	4
AW1848LINER	18" x 48" Shelf Liner	4
AW2436LINER	24" x 36" Shelf Liner	4
AW2460LINER	24" x 60" Shelf Liner	4
AW2472LINER	24" x 72" Shelf Liner	4



4" Swivel Caster

4" Swivel Caster w/ Brake

5" Swivel Caster w/ Brake

Caster Sets		
Model No.	Description	Pkg. Qty.
AWPCAST4	Set of 4 Casters - 2 w/Brakes (4")	1
AWPCAST5Y	Set of 4 Casters - 4 w/Brakes (5")	1

Wire Shelving Accessories		
Model No.	Description	Pkg. Qty.
AWFOOTLEVEL4PK	Set of 4 Leveling Steel Feet	4
AWFOOTPLATE4PK	Set of 4 Steel Feet Immobilizers	4
AWDONUT	Donut Bumper	1
AWSHOOK8PK	Set of 8 "S" Hooks	8
AWCLIP4PK	Set of 4 Quick-Adjust Clips	4

Label Holders

No more climbing or bending to read or scan a label!

- The angle label holder snaps securely to the face of most existing wire shelving.
- It allows the label face to be adjusted upward on low shelves and downward on high shelves for easy viewing and bar code scanning.
- Perfect for 1:1 labeling used in 5S Lean initiatives.
- The clear window protects the card stock label (provided).



Low



High

Angle Label Holder	Dimensions (In.)		Total No.			
Model No.	W	H	Cards Per Sheet	Sheets Per Pack	Cards Per Pack	Label Holders
29306	3	1-1/4	16	3	48	25

Flat Label Holder	Dimensions (In.)		Total No.			
Model No.	W	H	Cards Per Sheet	Sheets Per Pack	Cards Per Pack	Label Holders
29308	3	1-1/4	16	3	48	25

- The flat label holder attaches to the face of most wire shelving units.
- Perfect for 1:1 labeling used in 5S Lean initiatives.
- The clear window protects the card stock label (provided).



29306



29308



29306 label holder on wire shelving



29308 label holder on wire shelving

High Density Mobile Systems

- Allows shelving to be closely packed, eliminating wasted aisle space.
- Ergonomic handle can move 3000lbs per 11lb of force, making shelving easy to move for almost any user.
- Customizable to fit any shelving style or size.
- Mobilize your existing shelving.



Open mobile kit for steel high density storage



Closed mobile kit for high density storage



Open mobile kit for wire high density storage

Stack and Nest Containers

- Ideal for shipping, distribution and storage.
- Stack without lids for convenient storage and shipping.
- Totes nest when empty.
- Strong, industrial-grade polymer will not rust, corrode, or splinter.
- Long service life resulting in lower replacement costs.
- Manufactured from FDA-approved materials.
- SN2416 series containers are cross compatible.

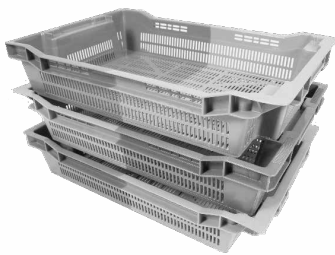
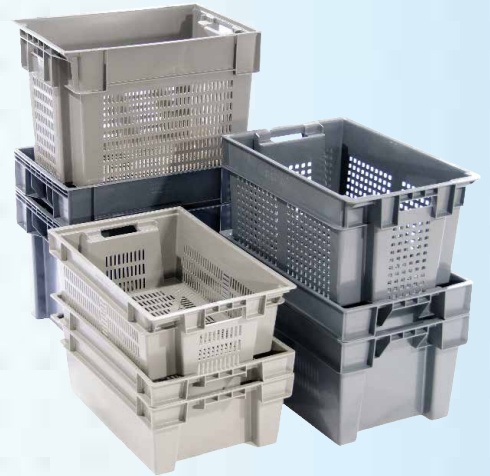

AC11020



SN24160800

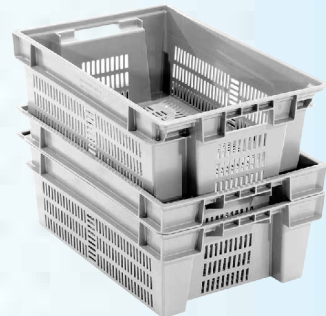

SN24160822



SN24161200

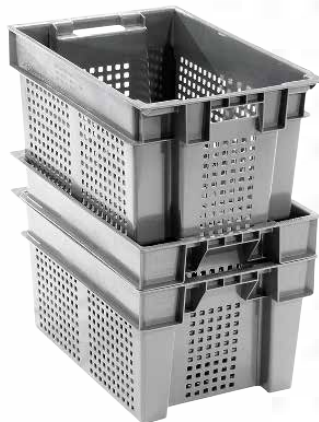

SN24161222

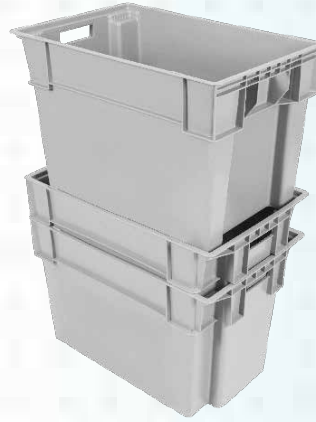

SN24161600

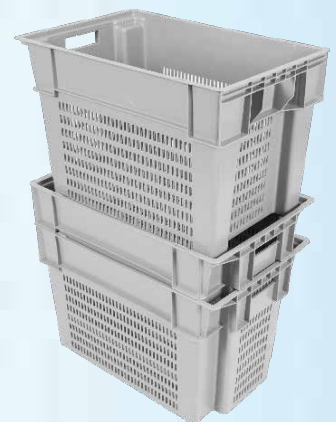

SN24161622



SN20161200

Nest and Stack Containers			Outside Dimensions (In.)			Specifications	
Model Number	Description	Available Color	Length	Width	Height	Capacity (lbs)	Pallet Quantity
AC11020	24" x 16" x 4" Stack and Nest Tote with Holes	Grey	24	16	4		
SN24160800	24" x 16" x 8" Stack and Nest Tote without Holes	Grey	24	16	8	44	150
SN24160822	24" x 16" x 8" Stack and Nest Tote with Holes	Grey	24	16	8	44	150
SN24161200	24" x 16" x 12" Stack and Nest Tote without Holes	Grey	24	16	12	44	115
SN24161222	24" x 16" x 12" Stack and Nest Tote with Holes	Grey	24	16	12	44	115
SN24161600	24" x 16" x 16" Stack and Nest Tote without Holes	Grey	24	16	16	44	80
SN24161622	24" x 16" x 16" Stack and Nest Tote with Holes	Grey	24	16	16	44	80

*Other colors available with minimum order.

Stack and Nest Containers

- Ideal for shipping, distribution and storage.
- Stack with or without lids for convenient storage and shipping.
- Totes nest when empty.
- Strong, industrial-grade polymer will not rust, corrode, splinter, or bend out of shape.
- Long service life resulting in lower replacement costs.
- Manufactured from FDA-approved materials.
- Multiple sizes and colors available.

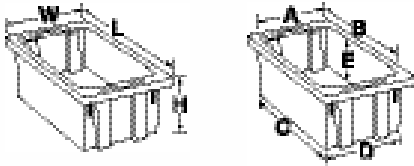

35200

Nest and Stack Containers		Outside Dimensions (In.)			Inside Dimensions (In.)					Capacity/Qty.		Accessories		
Model No.	Available Colors	Length	Width	Height	A	B	C	D	E	Cu. Ft.	Lbs.	Tote Ctn. Qty.	Lid Model	Lid Ctn. Qty.
35180	Blue, Gray, Red	18	11	6	10	15	14-3/8	9-3/8	5-7/8	0.5	45	6	35181	6
35185	Blue, Gray, Red	18	11	9	10	15	14-1/8	9-1/8	8-7/8	0.76	60	6	35181	6
35190	Blue, Gray, Red	19-1/2	15-1/2	10	14-1/2	15-1/2	14-3/4	13-1/2	9-7/8	1.2	65	6	35191	6
35195	Blue, Gray, Red	19-1/2	15-1/2	13	14-1/2	15-1/2	14-5/8	13-3/8	12-7/8	1.7	85	6	35191	6
35200	Blue, Gray, Red	19-1/2	13-1/2	8	12-3/8	15-3/4	15-1/4	11-1/2	7-7/8	0.8	55	6	35201	6
35225	Blue, Gray, Red	23-1/2	19-1/2	10	18-1/4	19-3/8	18	16-7/8	9-7/8	2	70	3	35231	3
35230	Blue, Gray, Red	23-1/2	19-1/2	13	18-1/8	19-3/8	18	16-7/8	12-7/8	2.6	90	3	35231	3
35240	Blue, Gray, Red	23-1/2	15-1/2	12	14-1/4	19-3/8	18-1/4	13	11-7/8	1.7	75	3	35241	3
35300	Blue, Gray, Red	29-1/2	19-1/2	15	18-1/4	25	23-1/2	16-5/8	14-7/8	3.7	100	3	35301	3

*Other colors available with minimum order. Order in carton quantities.



Optional lids protect contents from dust and damage



Clear plastic label holders accommodate labels up to 5" x 3-3/4"

Cross Stack and Nest Containers

- Color code like items for easy identification.
- Stack with lids or cross stack without lids.
- Containers nest when empty.
- Strong, industrial-grade polymer will not rust, corrode, or splinter.
- Long service life resulting in lower replacement costs.
- Manufactured from FDA-approved materials.
- Smooth interior for easy cleaning.
- Multiple color options available.



JL251609680

Cross Stack and Nest Container			Outside Dimensions (In.)			Inside Dimensions (In.)			Other Specifications		
Model No.	Description	Available Colors	Length	Width	Height	Length	Width	Height	Tare Weight (lbs)	Cu. Ft.	Capacity (lbs)
JL251609680	Cross Stack and Nest Jumbo Lug	Blue, Red, Green, Grey, Yellow, Natural	25	16	8-1/2	20-2/5	11-1/2	7-1/2	3.6	1.00	100
LJ251602000	Lid for JL251609680 Container	Natural	25-2/5	16-2/5	1-3/5	-	-	-	2	-	-

*Other colors available with minimum order.

Fiberglass Reinforced Containers

- Fiberglass reinforced containers nest when empty and stack when full by rotating 180°.
- Can be continuously used in temperatures ranging from -60° to 250° F (-51° to 121° C) and intermittently in temperatures 300° F and higher.
- Will not bend or sag under loads, and unlike metal, will not dent or corrode.
- Impervious to radiation, cutting oils, greases, solvents, detergents, mild acids and alkaline solutions within a pH rating of 3.0 – 10.0.
- Container can accommodate up to 500lbs.

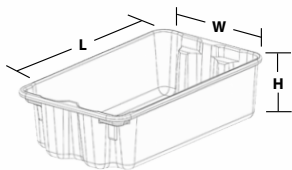

780508GREY

Fiberglass Reinforced Containers		Outside Dimensions Top (In.)			Inside Dimensions Bottom (In.)			Capacity (lbs)	Accessories	
Model No.	Available Color	L	W	H	L	W	H	Max. Cap.	Lids	Dolly
780008	Grey	42-1/2	20	14-1/4	35-7/8	17-3/8	14-1/8	500 lbs.	780118	-
780108	Grey	42-1/2	20	7-1/2	35-7/8	17	7-1/4	500 lbs.	780118	-
780208	Grey	17-7/8	10-5/8	5	14-1/8	9-1/2	4-7/8	500 lbs.	780218	780238
780308	Grey	19-3/4	12-1/2	6	16-1/4	11-3/8	5-7/8	500 lbs.	780318	780338
780408	Grey	20-1/2	12-7/8	8	16-3/8	11	7-7/8	500 lbs.	780418	780438
780508	Grey	24-1/4	14-3/4	8	18-1/2	12-3/4	7-7/8	500 lbs.	780518	780538
780608	Grey	25-1/4	18	10	20	16	9-7/8	500 lbs.	780618	780638
780708	Grey	27-1/2	20	14-1/8	24-7/8	17-3/8	13-1/8	500 lbs.	780718	780738
780808	Grey	25-1/4	18	6	20	16	5-3/4	500 lbs.	780618	780638

*Other Colors Available With Min. Order.



780608GREY



780708GREY



780808GREY

Attached Lid Containers

- Securely store and transport supplies.
- Maximum product protection.
- Smooth interior for easy cleaning.
- Stackable design, nestable when empty to save space.
- Durable lid with multiple interlocking teeth provides a durable, secure lid closure.
- Eliminate use of corrugated boxes.
- Multiple colors to easily color code and identify contents.
- Secure with optional tote snaps, zip ties, locks and more.
- Ergonomic handles designed for easy lifting and carrying.



AC21151202



For added security during transport or storage, use tote snaps or zip-ties.

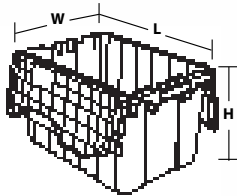

Containers nest when empty and stack on closed lids.



AR15141502

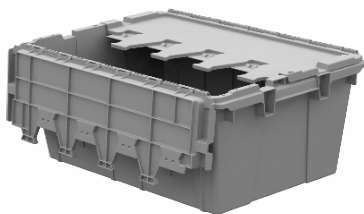

AC21150902

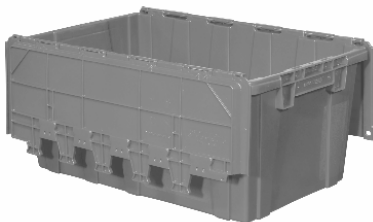

AR27171202

Attached Lid Containers		Outside Dimensions (In.)			Specifications		
Model No.	Available Colors	L	W	H	Cu. Ft.	Weight Capacity (Lbs.)	Tare Weight (Lbs.)
AR15141302	Grey	14-3/4	13-1/2	13-3/10	0.98	50	4.25
AR15141502	Grey	14-3/4	13-1/2	15-3/10	1.12	50	4.55
AR20120702	Grey	20	11-7/10	7-1/2	0.6	40	3.8
AC21150902	Grey, Green	21-4/5	15-1/10	9-3/5	1.1	60	5.1
AC21151202	Grey, Blue, Green, Red, Black	21-4/5	15-1/5	12-1/2	1.4	60	5.6
AS22131202	Grey	22-3/10	12-4/5	12-9/10	1.3	60	6.0
AR24201202	Grey, Blue	24	19-1/2	12-3/5	2.3	80	8.1
AR27170902	Green	27	16-9/10	9-3/5	1.7	80	7.6
AR27171202	Grey, Blue, Green, Red	27	16-9/10	12-1/2	2.3	100	8.2
AS28211502	Grey	28	20-4/5	15-2/5	3.6	100	12.6
AS34201502	Grey	34	24	19-3/5	6.1	100	19

*Other colors and sizes available with minimum order.

Clear Attached Lid Containers

- Securely store and transport supplies.
- Clear sides allow visibility of contents.
- Smooth interior for easy cleaning.
- Stackable design, nestable when empty to save space.
- Ideal for light to medium duty storage.
- Secure with optional tote snaps, zip ties, locks and more.
- Hanging file attached lid container has metal rails for hanging letter size folders.

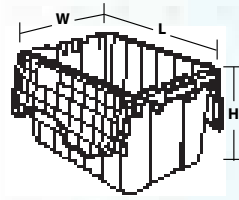

66497CLDGN



66486FILEB



66486CLDBL



66486CLDBL

Clear Attached Lid Container		Outside Dimensions (In.)			Capacity/Qty.			Specifications	
Model No.	Description	L	W	H	Cu. Ft.	Gal.	Lbs.	Ctn. Qty.	Stack Cap./ Qty. Stacked
66486CLDBL	Clear 12 gal. Attached Lid Container - Blue Lid	21-1/2	15	12-1/2	1.6	12	25	6	5
66486FILEB	Clear 12 gal. Attached Lid Container - Blue Lid, Hanging File Rails	21-1/2	15	12-1/2	1.6	12	25	6	5
66497CLDGN	Clear 18 gal. Attached Lid Container - Green Lid	21-1/2	15	17	2.3	17	35	3	4

*Other colors available with minimum order. Order in carton quantities.

Detached Lid Containers

- Ergonomic handles provide durable and comfortable grips for easy lifting and carrying.
- Large surface area for labeling.
- Containers stack firmly with lids, nest when empty for optimum space utilization.
- Detached lids snap tight for secure closure.
- Secure with optional tote snaps, zip ties, locks and more.
- Smooth interior for easy cleaning.



DR24200100



DL24201202

Detached Lid Containers			Outside Dimensions (In.)			Specifications		
Model No.	Available Colors	Description	L	W	H	Cu. Ft.	Weight Capacity (Lbs.)	Tare Weight (Lbs.)
DL21150902	Grey	Ergonomic Handle, Detached Lid Container	21-3/8	15-1/4	9-9/16	1.22	60	3.4
DL24201202	Grey	Ergonomic Handle, Detached Lid Container	24	20	12-3/8	2.36	100	5.5
DR21150100	Grey	Recessed Lid for DL21150902	21-3/8	15-1/4	1-1/8	-	-	1.6
DR24200100	Grey	Recessed Lid for DL24201202	24	20	1-1/8	-	-	2.0

*Other colors available with minimum order.

Grid Containers

- Create custom sized compartments using optional lengthwise and crosswise dividers.
- Great for organizing items and creating kits of items that are frequently used together.
- Multiple colors available for color coding and easy identification, also available in Clear, minimum quantities apply.
- Same footprint models are stackable.

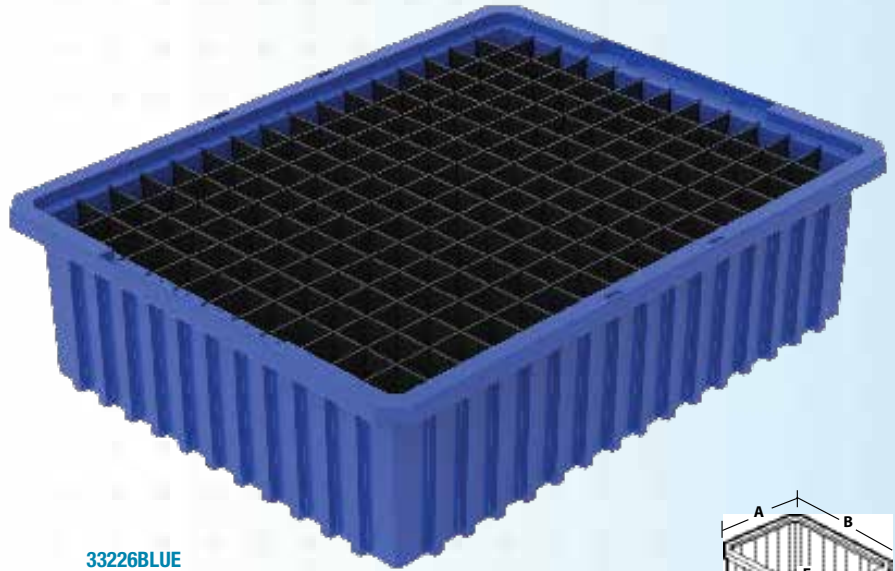

33226BLUE

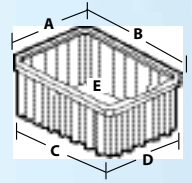

Clear snap-on lids keep contents clean and stack securely



Molded-in letter/number system for easy tracking



Dividers allow for the subdivision of containers

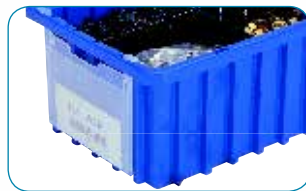

Clear plastic label holders snap on any side of the container

Grid Containers		Outside Dimensions (In.)			Capacity/Qty.				Accessories			
Model No.	In Stock Colors	L	W	H	Cu. Ft.	Gal	Lbs.	Bin Ctn. Qty.	Long Divider*	Short Divider*	Divider Pkg. Qty.	Max. No. of Compartments
33105	Blue, Gray, Red	10-7/8	8-1/4	5	.16	1.2	25	20	42105 (5)	41105 (7)	6	48
33162	Red	16-1/2	10-7/8	2-1/2	0.20	1.5	20	12	42162 (7)	41162 (7)	6	96
33164	Blue, Gray, Red	16-1/2	10-7/8	4	.29	2.2	20	12	42164 (7)	41164 (11)	6	96
33165	Red	16-1/2	10-7/8	5	0.39	2.9	35	12	42165 (7)	41165 (11)	6	96
33166	Blue, Gray, Red	16-1/2	10-7/8	6	.44	3.3	35	8	42166 (7)	41166 (11)	6	96
33168	Blue, Gray, Red	16-1/2	10-7/8	8	.59	4.4	40	6	42168 (7)	41168 (11)	6	96
33220	Blue, Gray, Red	22-3/8	17-3/8	10	1.66	12.4	50	2	42220 (11)	41220 (15)	6	192
33222	Blue, Gray, Red	22-1/2	17-1/2	12	2.10	15.9	60	3	42222 (11)	41222 (15)	6	192
33223	Blue, Gray, Red	22-1/2	17-3/8	3	.47	3.5	30	6	42223 (11)	41223 (15)	6	192
33224	Blue, Gray, Red	22-3/8	17-3/8	4	.61	4.6	30	6	42224 (11)	41224 (15)	6	192
33226	Blue, Gray, Red	22-3/8	17-3/8	6	.96	7.2	40	4	42226 (11)	41226 (15)	6	192
33228	Blue, Gray, Red	22-3/8	17-3/8	8	1.30	9.7	50	3	42228 (11)	41228 (15)	6	192
011-220	Grey	24-1/4	13	8	0.87	-	-	-	031-220 (7)	021-220 (17)	6	144

*Other colors available with minimum order. Order in carton quantities. *() = max # of dividers.



33165BLUE

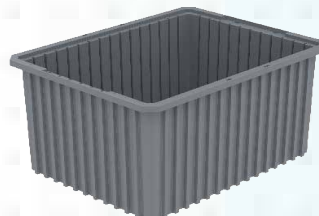

33222GREY



33224RED



011-220



011-220 Stacked

Label Holders		
Model No.	Fits Grid No.	Pkg. Qty.
35010	Fits all except 33164, 33223, 33224	6

Clear Snap-On Lids		
Model No.	Fits Grid No.	Ctn. Qty.
33011	33105	10
33061	33164, 33166, 33168	4
33023	33220, 33222, 33223, 33224, 33226, 33228	3

ProCart™

- Box cart or flat top, all in one!
- Versatile, all-purpose plastic utility cart.
- Quickly move supplies through your facility.
- Deep, molded-in compartments near the handle keep small items/supplies in reach.
- Bins, modular cabinets, tilt out bins and steel storage cabinets can be mounted under cart using a rail system (not included).
- Dent-resistant, rust-proof, never needs painting.
- Large ProCart included molded in cup holder.



Hinged side gates on both shelves flip up or down to convert the ProCart to a flat-top or box-top cart



I-Beam post makes it easy to load and unload boxes on the lower shelf



Optional rails utilize extra space with hanging and stacking bins, bin cabinets and tilt view storage bins.
(30900-Small, 30906-Large)



30936



30936, 19909, 30224 plus 30906



30936, 30234GREEN plus 30906



ProCart		Dimensions (In.)			Ctn. Qty.
Model No.	Description	L	W	H	
30936	Large ProCart Structural Foam Utility Cart	45-5/8	24	34-3/4	1
30930	Small ProCart Structural Foam Utility Cart	41-1/2	19	34-3/4	1
30900	Small Cart 9-Rail System for Hanging and Stacking Bins	-	-	-	1
30906	Large Cart 9-Rail System for Hanging and Stacking Bins	-	-	-	1

Linen, Recycling, and Waste Disposal Carts

- Thick, rugged tub walls for added durability and resistance to impact.
- Seamless bodies will not crack, chip, fade, rust, dent, splinter or corrode.
- Ergonomically designed for safe and easy loading and unloading.
- Light-duty, Medium-duty and heavy-duty styles available.
- Optional spring platforms make material handling easier and safer by eliminating excess bending.
- Optional lids protect content and reduces dust build up.



145B Cart with 145SPRING Platform



Corner Caster | Diamond Caster

Economy Carts		Outside Dimensions (In.)			Specifications			
Model No.	Description	W	D	H	Caster Pattern	Bushels	Cu. Ft.	Load Rating
111ECS	Light-Duty Cart, 100% Recycled Plastic	36.5	24.5	26	Corner	8	9	175 lbs.
125EC	Light-Duty Cart, 100% Recycled Plastic	39	27	29	Corner	10	12	200 lbs.

Mini Carts		Outside Dimensions (In.)			Specifications			
Model No.	Description	W	D	H	Caster Pattern	Bushels	Cu. Ft.	Load Rating
100A	Mini Cart	21	21	27	Corner	4	5	200 lbs.
105A	Mini Cart	33	19	28	Corner	5	6	200 lbs.
350A	Mini Cart	33	23	24	Corner	6	7	200 lbs.
108A	Mini Cart	24	24	38	Corner	6	7	200 lbs.
110A	Mini Cart	35	25	24	Corner	7	8	300 lbs.
115A	Mini Cart	48	19	28	Corner	8	9	300 lbs.

*Other sizes and customizations available upon request.

Regular-Duty Carts		Outside Dimensions (In.)			Specifications			
Model No.	Description	W	D	H	Caster Pattern	Bushels	Cu. Ft.	Load Rating
125A	Regular-Duty Cart	39	27	30	Diamond	10	12	400 lbs.
135A	Regular-Duty Cart	41	29	31	Diamond	12	15	400 lbs.
145A	Regular-Duty Cart	43	31	33	Diamond	14	16	400 lbs.

*Other sizes and customizations available upon request.

Heavy-Duty Carts		Outside Dimensions (In.)			Specifications			
Model No.	Description	W	D	H	Caster Pattern	Bushels	Cu. Ft.	Load Rating
125B	Heavy-Duty Cart	39	27	31	Corner /Diamond	10	12	800 lbs.
135B	Heavy-Duty Cart	43	31	33	Corner /Diamond	12	15	800 lbs.
145B	Heavy-Duty Cart	43	31	34	Corner /Diamond	14	16	800 lbs.
155B	Heavy-Duty Cart	43	31	36	Corner /Diamond	16	19	800 lbs.

*Other sizes and customizations available upon request. Specify caster pattern upon order.

Optional Cart Accessories	
Model No.	Description
125L	Lid for 125EC, 125A, 125B Carts
145L	Lid for 145A, 145B, 155B Carts
125SPRING	Spring platform for 125 Series Carts
145SPRING	Spring platform for 135, 145, 150, and 155 Series Carts

*Other sizes and customizations available upon request.



125EC



100A

105A



125A



145B Corner Caster

Easy Access Carts

- Thick, rugged tub walls for added durability and resistance to impact.
- Seamless bodies will not crack, chip, fade, rust, dent, splinter or corrode.
- Reduce stress and strain on lower back with easy access cut out.
- Optional spring platforms make material handling easier and safer by eliminating excess bending.

Easy Access Carts		Outside Dimensions (In.)			Specifications			
Model No.	Description	W	D	H	Caster Pattern	Bushels	Cu. Ft.	Load Rating
150B	Easy Access Cart	43	31	36	Corner /Diamond	16	19	800 lbs.
165B	Easy Access Cart	46	31	39	Corner /Diamond	18	21	900 lbs.
175B	Easy Access Cart	46	31	49	Corner /Diamond	21	24	900 lbs.
185B	Easy Access Cart	63	31	39	Corner /Diamond	21	24	900 lbs.

*Other customizations available upon request. Specify caster pattern upon order.

EASY ACCESS TO REMOVE CONTENTS EASILY



Next Generation Utility Cart

- Double wall box-style lip for extra durability and impact resistance.
- Better roll-ability and maneuverability with the pairing of two heavy duty casters up front and two poly-core wheels in the rear.
- Seamless bodies will not crack, chip, fade, rust, dent, splinter or corrode.
- Steel undercarriage for added strength.
- Ergonomic molded in handles for comfortable handling.

DOUBLE WALL COLLAR



730B GREY

Next Generation Utility Cart		Outside Dimensions (In.)			Specifications			
Model No.	Description	W	D	H	Wheel Diameters (In.)	Bushels	Cu. Ft.	Load Rating
730B	Next Generation Utility Cart	48	31	34-1/2	10 + 5	14	16	1000 lbs.
750B	Next Generation Utility Cart	60	31-1/2	35-1/2	12 + 5	19	24	1000 lbs.
770B	Next Generation Utility Cart	72	35-1/2	40	12 + 6	32	39	1500 lbs.

*Other customizations available upon request. Specify caster pattern upon order.

Tilt Trucks

- Thick, rugged tub walls for added durability and resistance to impact.
- Seamless bodies will not rust, dent or need painting.
- “C” Series tilt trucks come with a unique molded boxed collar which strengthens much better than a steel frame.
- Wheel base and heavy-duty caster combination provides easy maneuverability even with heavy loads.
- Optional lids available for select models.

100% RECYCLED
PLASTIC OPTION



420EC

Economy Tilt Truck		Outside Dimensions (In.)			Specifications			
Model No.	Description	W	D	H	Wheel Diameters (In.)	Handle	Cu. Yd.	Load Rating
420EC	Light-Duty Tilt Truck, 100% Recycled Plastic	55	28	38	10 + 4	-	5/8	300 lbs.

Note: Some tilt trucks are very large. Please measure doorways tilt trucks may travel through.



420LT

441LT

460LT

480LT

Regular-Duty Tilt Trucks		Outside Dimensions (In.)			Specifications			
Model No.	Description	W	D	H	Wheel Diameters (In.)	Handle	Cu. Yd.	Load Rating
420LT	Regular-Duty Tilt Truck	55	28	38	10 + 4	-	5/8	400 lbs.
441LT	Regular-Duty Tilt Truck	63	35	40	12 + 3	Molded	1-1/10	500 lbs.
460LT	Regular-Duty Tilt Truck	77	43	50	12 + 4	Molded	1-1/2	600 lbs.
480LT	Regular-Duty Tilt Truck	73	47	56	12 + 5	Wrapped Steel	2	800 lbs.

*Other sizes and customizations available upon request.



420C

441C

460C

480C

Heavy Duty Tilt Truck		Outside Dimensions (In.)			Specifications			
Model No.	Description	W	D	H	Wheel Diameters (In.)	Handle	Cu. Yd.	Load Rating
420C	Heavy-Duty Tilt Truck	58	29	38	10 + 4	Molded	5/8	1000 lbs.
441C	Heavy-Duty Tilt Truck	68	36	42	12 + 4	Molded	1-1/10	1200 lbs.
460C	Heavy-Duty Tilt Truck	81	44	50	12 + 4	Molded	1-1/2	1500 lbs.
480C	Heavy-Duty Tilt Truck	74	48	56	12 + 5	Molded	2	2000 lbs.

*Other sizes and customizations available upon request.

Waste and Recycling Containers

- Designed for separation of cans, bottles, fine paper, newspaper and waste.
- Container comes complete with round or slot lid. Optional bilingual labels available.

16 Gal. Bullseye		Outside Dimensions (In.)			Specifications		
Model No.	Description	L	W	H	Capacity (Imp. Gal.)	Capacity (L)	Lid Style
549A	Bullseye 16 Gal., Round Hole	20-1/2	11	34	16	72.7	Round Hole
549B	Bullseye 16 Gal., Slot Hole	20-1/2	11	34	16	72.7	Slot Hole

*Other colors and customizations available upon request.



549A

549B



559B

559A

- Designed for recycling materials in offices, cafeterias, and high volume areas.
- Round hole is for cans and bottles. Square hole is for paper, recyclables or waste.

30 Gal. Bullseye		Outside Dimensions (In.)			Specifications		
Model No.	Description	L	W	H	Capacity (Imp. Gal.)	Capacity (L)	Lid Style
559A	Bullseye 30 Gal., Round Hole	20-1/2	20-1/2	34	30	136.4	Round Hole
559B	Bullseye 30 Gal., Slot Hole	20-1/2	20-1/2	34	30	136.4	Slot Hole

*Other colors and customizations available upon request.

- Designed for recycling cans, bottles, paper, or waste.
- Available as either half, or mounted back to back, with or without dolly.

Half Moon Bullseye		Outside Dimensions (In.)			Specifications		
Model No.	Description	L	W	H	Capacity (Imp. Gal.)	Capacity (L)	Lid Style
519A	Half Moon Bullseye, Round Hole	22-1/2	12-1/4	36	15	68.2	Round Hole
519B	Half Moon Bullseye, Slot Hole	22-1/2	12-1/4	36	15	68.2	Slot Hole

*Other colors and customizations available upon request.



519A

519B

519C



108JB

- Largest Bullseye designed for cans and bottles on a large quantity basis.
- Includes round hole and insect prevention flap. Optional bilingual labels available.

Jumbo Bullseye		Outside Dimensions (In.)			Specifications		
Model No.	Description	L	W	H	Capacity (Imp. Gal.)	Capacity (L)	Lid Style
108JB	Jumbo Bullseye, Round Hole	24-1/2	24-1/2	34	45	204.6	Round Hole

*Other colors and customizations available upon request.

- Combo hole design can accommodate all your recycling/waste disposal needs.
- Lids and bases available in different colors to manage stations more efficiently.

Hole in One Bullseye		Outside Dimensions (In.)			Specifications		
Model No.	Description	L	W	H	Capacity (Imp. Gal.)	Capacity (L)	Lid Style
550	Hole in One Bullseye	17	17	31	22	114	Combo Hole

*Other colors and customizations available upon request.



550 Multi Color



075611



RC25141401

- Under table and counter recycling containers are suitable for cans, bottles, and paper recycling.

Under Counter Recycling		Outside Dimensions (In.)		
Model No.	Description	L	W	H
075611	Medium Blue Bin with Drain Holes	20-3/4	15	12
RC25141401	Large Blue Bin with Drain Holes	25	17	13

*Other colors available with minimum order.

Bullseye Twin and Triplet



- Recycling and waste disposal in one unit.
- Smooth ergonomic design for easy cleaning.
- A range of attractive color options to choose from.
- Optional black base for increased recycle content.
- A variety of labels are included with every unit.
- Lid is hinged.
- Twin unit comes with two liners, Triplet comes with three (12 Imp. Gal. liners).
- Either hole can be trimmed out larger.



Bullseye Twin	Outside Dimensions (In.)			Specifications		
	Model No.	L	W	H	Capacity (Imp. Gal.)	Capacity (L)
585	33	17	28	12/15 x 2	55 x 2	Mixed

*Other colors and customizations available upon request.

Bullseye Triplet	Outside Dimensions (In.)			Specifications		
	Model No.	L	W	H	Capacity (Imp. Gal.)	Capacity (L)
595	47	17	28	12/15 x 3	55 x 3	Mixed

*Other colors and customizations available upon request.

Bullseye Duo and Trio

- Waste and recycling combined in one convenient station.
- Available in a variety of standard and premium colors.
- Duo comes with two plastic liners, and Trio comes with 3 liners.
- A variety of labels are included with every unit.
- Lockable for extra security.
- Stainless steel hinges.



565BLUE



Bullseye Duo	Outside Dimensions (In.)			Specifications		
	Model No.	L	W	H	Capacity (Imp. Gal.)	Capacity (L)
565	36	19	38	18/22 x 2	82 x 2	Mixed

*Other colors and customizations available upon request.

Bullseye Trio	Outside Dimensions (In.)			Specifications		
	Model No.	L	W	H	Capacity (Imp. Gal.)	Capacity (L)
575	54	19	38	18/22 x 3	82 x 3	Mixed

*Other colors and customizations available upon request.



575SANDSTONE

Versatile Platform Trucks

Versatile Structural Foam Platform Truck

- Ideal for heavy-duty jobs with up to 2,000 lb. capacity.
- Non-skid structural foam deck is easy-to-clean and won't rot, chip or rust.
- Handles and rails feature a durable, powder-coated finish.
- Customize to your exact needs with multiple size and caster options.

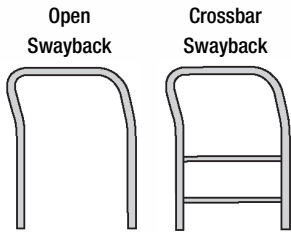

R90182A1411



Four molded-in tie-down slots for securing items during transport



Steel outside deck handle pockets are welded to under deck reinforcements. Jam bolts, standard on all models, hold handles in place



Under deck steel reinforcements and bolt-on casters provide durability and a weight capacity of up to 2,000 lbs.

Versatile Platform Truck				
Model No.	Deck Size	Handle Type	Caster Type	Caster Size (In.)
R90182A1411	24 x 48	Open	Pro-Tech Polyurethane	6
R90182A1412	24 x 48	Crossbar	Pro-Tech Polyurethane	6
R90185A1412	24 x 48	Crossbar	Pro-Tech Polyurethane	6
R90282A1011	30 x 60	Open	Pro-Tech Polyurethane	6
R90282A1012	30 x 60	Crossbar	Pro-Tech Polyurethane	6
R90285A1011	30 x 60	Open	Thermoplastic	8

*Ships in carton unassembled.

Fire Safety Storage

- Sturdy all welded double wall steel construction.
- Durable, rust and acid resistant safety yellow powder coat.
- In full compliance with OSHA and NFPA standards when used properly.
- Flammable danger/warnings on door.



1045M-50



1012M-50



EGVC18-50

Flammable Safety Storage						
Model No.	Description	Color	Shelves	Width	Depth	Height
EGVC18-50	18 Cylinder Cap., Vertical Gas Cylinder Cabinet	Yellow	-	60	30	71-27/32
1012M-50	12 Gal., Manual Door Flammable Safety Cabinet	Yellow	1	23	18	35
1045M-50	45 Gal., Manual Door Flammable Safety Cabinet	Yellow	2	43	18	65

*Other sizes and styles available upon request with minimum order.

Premium All Purpose Lockers

- Premium all purpose lockers with traditional louvered doors are designed for storage of all personal belongings.
- Lockers can be ordered fully-assembled or knock-down for assembly at the destination.
- Available in 1-wide as well as 3-wide.
- Aluminum number plates with mounting hardware is included.
- Available in multiple colors and sizes.

Single Tier Lockers			Dimensions (In.)				Specifications	
Model No.	Color	Grouping	Width	Depth	Opening Height	Frame Height	Tier	Openings Per Group
U1228-1	Grey	1-Wide	12	12	72	78	1	1
U3228-1	Grey	3-Wide	12	12	72	78	1	3
U1258-1	Grey	1-Wide	12	15	72	78	1	1
U3258-1	Grey	3-Wide	12	15	72	78	1	3
U1288-1	Grey	1-Wide	12	18	72	78	1	1
U3288-1	Grey	3-Wide	12	18	72	78	1	3

*Other sizes and customizations available upon request.



Double Tier Lockers			Dimensions (In.)				Specifications	
Model No.	Color	Grouping	Width	Depth	Opening Height	Frame Height	Tier	Openings Per Group
U1228-2	Grey	1-Wide	12	12	36	78	2	2
U3228-2	Grey	3-Wide	12	12	36	78	2	6
U1258-2	Grey	1-Wide	12	15	36	78	2	2
U3258-2	Grey	3-Wide	12	15	36	78	2	6
U1288-2	Grey	1-Wide	12	18	36	78	2	2
U3288-2	Grey	3-Wide	12	18	36	78	2	6

*Other sizes and customizations available upon request.

Triple Tier Lockers			Dimensions (In.)				Specifications	
Model No.	Color	Grouping	Width	Depth	Opening Height	Frame Height	Tier	Openings Per Group
U1228-3	Grey	1-Wide	12	12	24	78	3	3
U3228-3	Grey	3-Wide	12	12	24	78	3	9
U1258-3	Grey	1-Wide	12	15	24	78	3	3
U3258-3	Grey	3-Wide	12	15	24	78	3	9
U1288-3	Grey	1-Wide	12	18	24	78	3	3
U3288-3	Grey	3-Wide	12	18	24	78	3	9

*Other sizes and customizations available upon request.



Promptlii

Prompt | Professional | Service

www.promptlii.com

Phone: (587) 287-2007

Email: customerservice@promptlii.com