

Promptlii

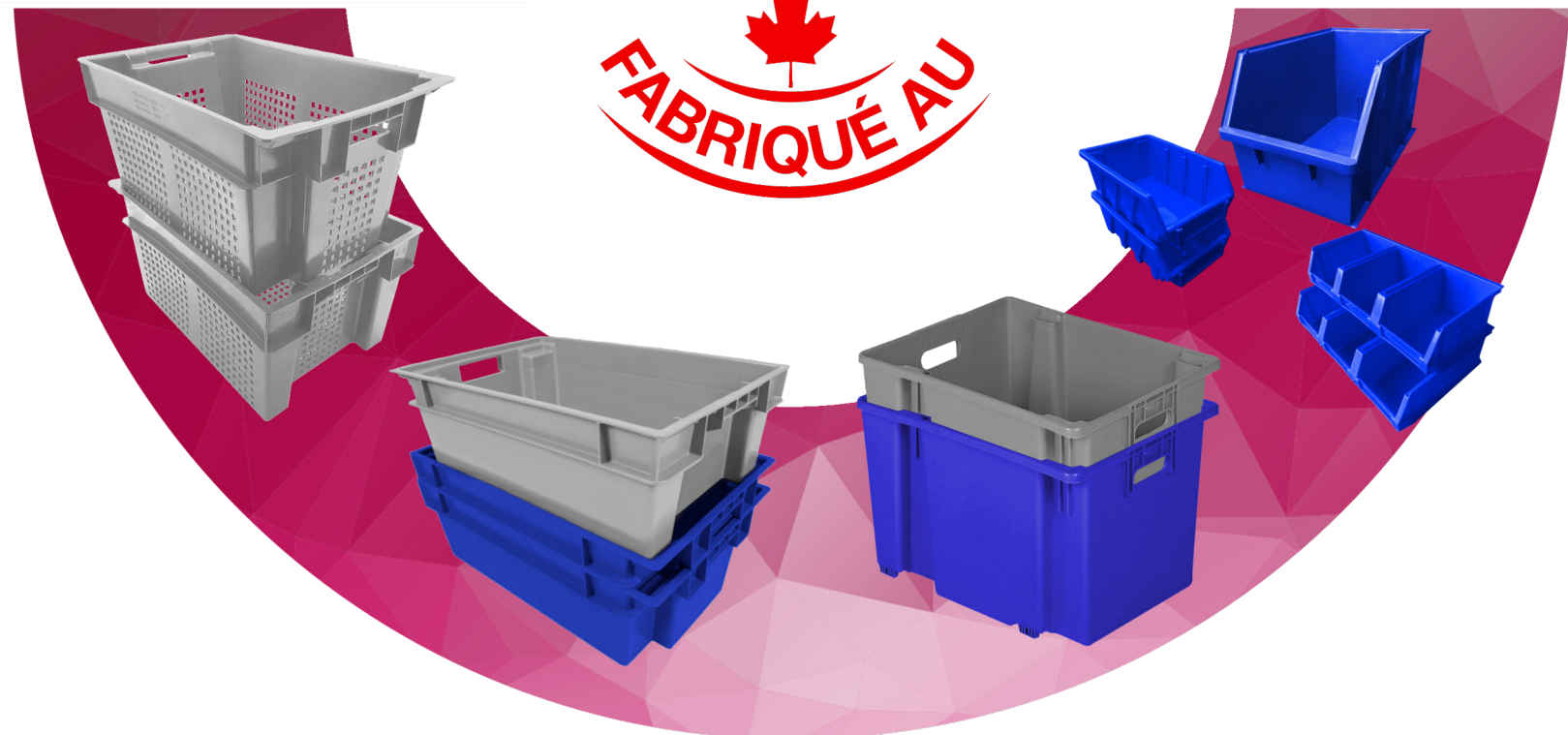

MADE IN
CANADA

FABRIQUÉ AU



Prompt | Professional | Service

www.promptlii.com

Stack and Nest Containers:

Features/Benefits:

- Ideal for shipping, distribution and storage.
- Stack without lids for convenient storage and shipping.
- Totes nest when empty.
- Strong, industrial-grade polymer will not rust, corrode, or splinter.
- Long service life resulting in lower replacement costs.
- Manufactured from FDA-approved materials.
- **Standard footprint, containers are cross compatible.**
- Five per layer on a standard 48" x 40" Pallet.

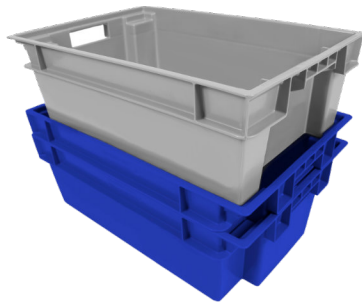

SN2416080021000 (Grey)
SN2416080023000 (Blue)



SN2416082221000 (Grey)

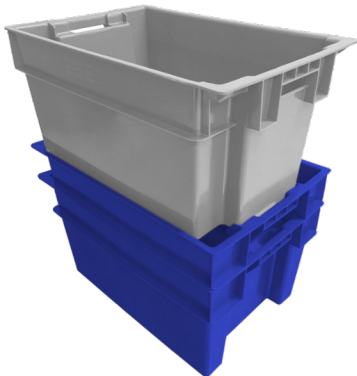

SN2416120021000 (Grey)
SN2416120023000 (Blue)

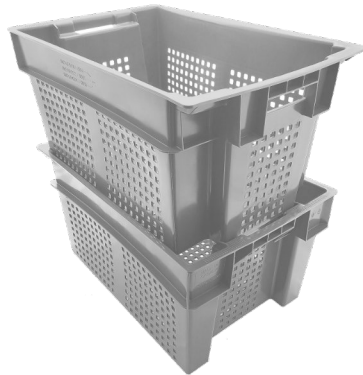

SN2416122221000 (Grey)



SN2416160021000 (Grey)
SN2416160023000 (Blue)

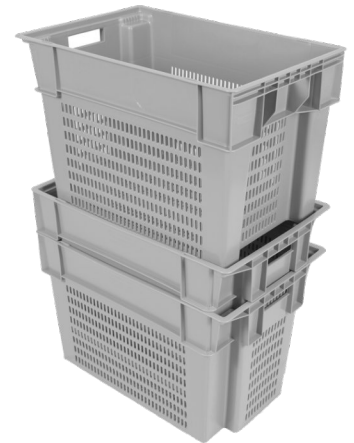

SN2416162221000 (Grey)

Stack and Nest Containers											
Model Number	Description	Stocked Colours	Outside Dimensions (In.)			Inside Dimensions (In.)			Other Specifications		
			Length	Width	Height	Length	Width	Height	Weight (lbs)	Capacity (lbs)	Pallet Quantity
SN24160800	24" x 16" x 8" Stack and Nest Container without Holes	Blue, Grey	24.00	16.00	8.00	19.50	13.25	7.75	4.00	80.00	175
SN24160822	24" x 16" x 8" Stack and Nest Container with Holes	Grey	24.00	16.00	8.00	19.50	13.25	7.75	3.20	80.00	175
SN24161200	24" x 16" x 12" Stack and Nest Container without Holes	Blue, Grey	24.00	16.00	12.00	19.50	13.25	11.75	4.80	80.00	115
SN24161222	24" x 16" x 12" Stack and Nest Container with Holes	Grey	24.00	16.00	12.00	19.50	13.25	11.75	4.40	80.00	115
SN24161600	24" x 16" x 16" Stack and Nest Container without Holes	Blue, Grey	24.00	16.00	16.00	19.50	13.25	15.75	6.60	80.00	80
SN24161622	24" x 16" x 16" Stack and Nest Container with Holes	Grey	24.00	16.00	16.00	19.50	13.25	15.75	6.10	80.00	80

*Other colours and customizations available with minimum order.

Stack and Nest Containers:

Features/Benefits:

- Ideal for shipping, distribution and storage.
- Stack without lids for convenient storage and shipping.
- Totes nest when empty.
- Strong, industrial-grade polymer will not rust, corrode, or splinter.
- Long service life resulting in lower replacement costs.
- Manufactured from FDA-approved materials.



C18702E09 (Blue)
C18702E01 (Grey)



SN2016120021000 (Grey)
SN2016120023000 (Blue)



SN2114120021000 (Grey)

Stack and Nest Containers

Model Number	Description	Stocked Colours	Outside Dimensions (In.)			Inside Dimensions (In.)			Other Specifications		
			Length	Width	Height	Length	Width	Height	Weight (lbs)	Capacity (lbs)	Pallet Quantity
SN20161200	20" x 16" x 12" Heavy Duty Stack and Nest Container	Blue, Grey	20.00	16.00	12.00	17.50	11.13	11.13	4.00	60.00	132
SN21141200	21" x 14" x 12" Heavy Duty Stack and Nest Container	Grey	21.00	14.00	12.00	17.00	8.00	11.00	4.00	70.00	132
C18702	32" x 18" x 12" Heavy Duty Stack and Nest Container	Blue, Grey	31.63	18.38	12	24.81	15.56	10.50	8.60	125.00	69

*Other colours and customizations available with minimum order.

Cross Stack and Nest Containers:

Features/Benefits:

- Ideal for shipping, distribution and storage.
- Stack with or without lids.
- Totes nest when empty.
- Strong, industrial-grade polymer will not rust, corrode, or splinter.
- Long service life resulting in lower replacement costs.
- Manufactured from FDA-approved materials.



JL2516096800000AK (White)
JL2516096801000AK (Grey)
JL2516096802000AK (Red)
JL2516096804000AK (Green)
JL2516096809000AK (Blue)
JL2516096818000AK (Yellow)

Cross Stack and Nest Containers

Model Number	Description	Stocked Colours	Outside Dimensions (In.)			Inside Dimensions (In.)			Other Specifications		
			Length	Width	Height	Length	Width	Height	Weight (lbs)	Capacity (lbs)	Pallet Quantity
JL25160968	25" x 16" x 9", Jumbo Lug Cross Stack and Nest Container	Blue, Green, Grey, Red, White, Yellow	25.00	16.00	8.50	20.40	11.50	7.50	3.60	100.00	200

*Other colours and customizations available with minimum order.

Stack and Nest Containers:

Features/Benefits:

- Ideal for shipping, distribution and storage.
- Stack without lids for convenient storage and shipping.
- Totes nest when empty.
- Strong, industrial-grade polymer will not rust, corrode, or splinter.
- Long service life resulting in lower replacement costs.
- Manufactured from FDA-approved materials.



007640BLUE



007641ORANGE



007644GREEN



007648BEIGE

Stack and Nest Containers												
Model Number	Description	Stocked Colours	Outside Dimensions (In.)			Inside Dimensions (In.)			Other Specifications			
			Length	Width	Height	Length	Width	Height	Weight (lbs)	Capacity (lbs)	Pallet Quantity	
007640	19" x 19" x 10-1/2" Stack and Nest Container without Holes	Blue	19.00	19.00	10.50	15.38	15.38	10.00	4.24	45.00	72	
007641	19" x 19" x 10-1/2" Stack and Nest Container with Holes	Orange	19.00	19.00	10.50	15.38	15.38	10.00	4.08	45.00	72	
007644	23-1/2" x 18-1/2" x 12" Vented Stack and Nest Container	Green	23.50	18.50	12.25	19.13	16.00	11.25	5.30	75.00	80	
007648	22" x 14-1/2" x 14-1/2" Stack and Nest Container with Holes	Beige	22.00	14.50	14.50	17.50	10.00	13.88	4.92	50.00	80	

*Other colours and customizations available with minimum order.

Stack and Nest Trays:

Features/Benefits:

- Ideal for shipping, distribution and storage.
- Trays are vented for maximum air flow.
- Stack without lids for convenient storage and shipping.
- Trays nest when empty.
- Strong, industrial-grade polymer will not rust, corrode, or splinter.
- Long service life resulting in lower replacement costs.
- Manufactured from FDA-approved materials.



AG2016042201000

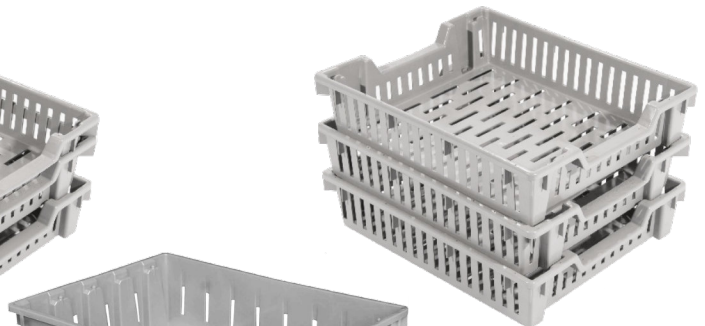

AG2016052201000



AG1914052251000

Stack and Nest Trays												
Model Number	Description	Stocked Colours	Outside Dimensions (In.)			Inside Dimensions (In.)			Other Specifications			
			Length	Width	Height	Length	Width	Height	Weight (lbs)	Capacity (lbs)	Pallet Quantity	
AG191405	19" x 14" x 5" Ventillated Stack and Nest Tray	Grey	18.75	13.63	4.56	16.50	12.50	4.00	1.63	20.00	348	
AG201604	20" x 16" x 4" Ventillated Stack and Nest Tray	Grey	19.50	16.38	4.19	16.63	14.63	3.50	1.68	20.00	340	
AG201605	20" x 16" x 5" Ventillated Stack and Nest Tray	Grey	19.50	16.38	5.00	16.70	14.63	4.50	1.72	20.00	300	

*Other colours and customizations available with minimum order.

Detached Lid Containers:

Features/Benefits:

- Containers stack firmly with lids.
- Containers nest when empty.
- Containers interwork for optimum space utilization.
- Detached lids snap tight for secure closure.
- Manufactured from FDA-approved materials.
- CFIA Approved.
- Cross stack Five per layer on a 48" x 40" pallet for secure load.



C18541E05



C18541E05 with C18525E05 (Lid)

Detached Lid Containers

Model Number	Description	Stocked Colours	Outside Dimensions (In.)			Inside Dimensions (In.)			Other Specifications		
			Length	Width	Height	Length	Width	Height	Weight (lbs)	Capacity (lbs)	Pallet Quantity
C18541	24" x 16" x 9" Nest Pack Container	Beige	24.00	16.00	8.75	20.00	12.88	8.25	4.28	50.00	210

*Other colours and customizations available with minimum order.

Attached Lid Containers:

Features/Benefits:

- Reusable for shipping, distribution, and storage containers.
- Textured bottoms provide a sure grip on conveyor belts.
- Ergonomic handles designed for easy lifting and carrying.
- Padlock eye on both ends accommodate security ties.
- Reinforced hinge pins for years of smooth lid operation.
- Attached lids snap securely closed to protect contents.
- Containers stack on closed lids and nest when lids are open.

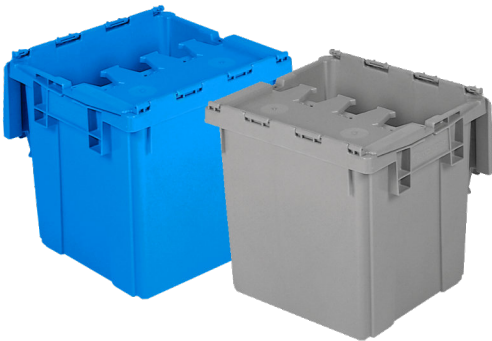

AR1514130001000 (Grey)
AR1514130003000 (Blue)



AR1514150001000

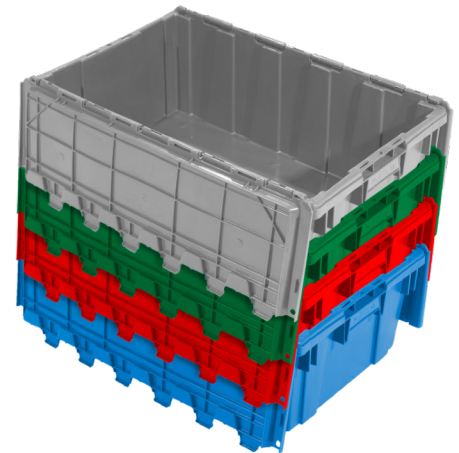

AR2717090201000 (Grey)
AR2717090202000 (Red)
AR2717090204000 (Green)
AR2717090209000 (Blue)

Attached Lid Containers

Model Number	Description	Stocked Colours	Outside Dimensions (In.)			Inside Dimensions (In.)			Other Specifications		
			Length	Width	Height	Length	Width	Height	Weight (lbs)	Capacity (lbs)	Pallet Quantity
AR15141300	15" x 14" x 13" Attached Lid Container, Traction Bottom	Blue, Grey	14.75	13.50	13.31	11.25	11.25	11.88	4.98	50.00	160
AR15141500	15" x 14" x 15" Attached Lid Container, Traction Bottom	Grey	14.75	13.50	15.22	11.25	11.25	13.81	5.08	50.00	138
AR27170902	27" x 17" x 9" Attached Lid Container, Traction Bottom	Blue, Green, Grey, Red	27.00	16.90	9.63	23.88	14.13	8.00	7.52	80.00	81

*Other colours and customizations available with minimum order.

Nesting Containers:

Features/Benefits:

- Ideal for order picking and harvesting.
- Solid or vented sides.
- Made from FDA approved materials.
- Nest when empty for compact storage.
- Will not rust or splinter.



007670GREEN



007678RED



007671GREEN

Nesting Containers									
Model Number	Description	Stocked Colours	Outside Dimensions (In.)			Other Specifications			
			Length	Width	Height	Weight (lbs)	Capacity (lbs)	Pallet Quantity	
007670	15" Diameter x 13"H Ventillated Picking Basket	Green	15.00	15.00	13.00	2.00	40.00	496	
007671	15" Diameter x 13"H Solid Picking Basket	Green	15.00	15.00	13.00	2.20	40.00	496	
007678	12" Diameter x 13"H Ventillated Picking Basket	Red	12.00	12.00	13.00	1.82	35.00-	696	

*Other colours and customizations available with minimum order.

General Purpose Containers:

Features/Benefits:

- Ideal for order picking, work in process, or storage.
- Ergonomic Handle.
- Will not rust or splinter.
- Nest for compact storage.
- 075611 can cross stack.



075611GREY



075611BLUE



075618BLUE
075618GREY

General Purpose Containers											
Model Number	Description	Stocked Colours	Outside Dimensions (In.)			Inside Dimensions (In.)			Other Specifications		
			Length	Width	Height	Length	Width	Height	Weight (lbs)	Capacity (lbs)	Pallet Quantity
075611	21" x 15" x 12" General Purpose Container	Blue, Grey	20.75	15.00	12.00	19.00	13.50	11.75	3.65	40.00	180
075618	25" x 17" x 13" General Purpose Container	Blue, Grey	25.00	17.00	13.00	23.00	15.50	13.00	4.92	50.00	140

*Other colours and customizations available with minimum order.

Multi-Purpose Trays:

Features/Benefits:

- Tongue-and-groove design for positive, secure tray stacking.
- Low walls for easy product access.
- Two-way or four-way hand truck entry allows for accessibility and convenient moving and loading.
- Open-grid bottom and open sides allow maximum air flow for product ventilation.
- Stack and nest within footprints to eliminate wasted space and reduce backhaul space.
- Allow full cube of trailers, reducing transport costs.
- Combine with plastic or steel dollies for easy transport.
- Molded of HDPE; will not corrode or splinter.
- 100% recyclable.
- Use with temperatures of -20° to 120° F.



BA2320042205000



BA2622062205000

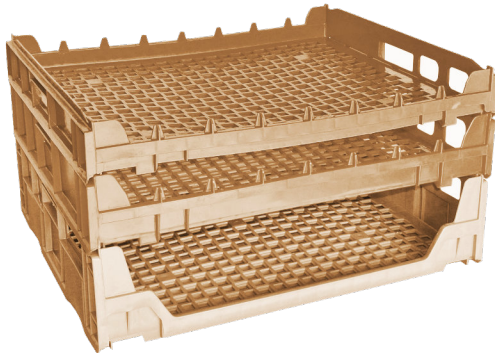

← BA2622032205000

← BA2622052205000

← BA2622072205000

THE RIGHT TRAY, AT THE RIGHT PLACE, AT THE RIGHT TIME!



BL2723062305000

Multi-Purpose Trays

Model Number	Description	Stocked Colours	Outside Dimensions (In.)			Inside Dimensions (In.)			Other Specifications		
			Length	Width	Height	Length	Width	Height	Weight (lbs)	Capacity (lbs)	Pallet Quantity
BA23200422	23" x 20" x 4" Stack and Nest Multi-Purpose Tray	Red	22.75	20.25	3.63	22.00	19.25	2.88	2.50	10.00	240
BA26220322	26" x 22" x 3" Stack and Nest Multi-Purpose Tray	Beige	26.75	21.50	3.44	24.75	20.75	2.69	2.67	10.00	84
BA26220522	26" x 22" x 5" Stack and Nest Multi-Purpose Tray	Beige	26.75	21.50	4.75	24.75	20.75	3.60	2.75	10.00	84
BA26220622	26" x 22" x 6" Stack and Nest Multi-Purpose Tray	Beige	26.50	22.25	5.75	25.75	21.25	5.00	4.13	18.00	70
BA26220722	26" x 22" x 7" Stack and Nest Multi-Purpose Tray	Beige	26.75	21.50	6.56	24.75	20.75	5.50	3.50	20.00	74
BL27230623	27" x 23" x 6" Stack and Nest Multi-Purpose Tray	Beige	27.44	23.44	5.50	24.88	22.50	5.19	5.50	20.00	70

*Other colours and customizations available with minimum order.

Hanging and Stacking Bins:

Features/Benefits:

- Superior construction allows for being fully loaded without the risk of bulging or cracking.
- Tough, durable and easy to clean.
- Stack securely to maximize space, or hang off panels or rails to meet your storage needs.
- Resistant to oil and grease.
- Will not splinter, warp or crack under normal use.
- Outlasts corrugate bins by many years.



AW30210BLUE

AW30220BLUE

AW30230BLUE



AW30250BLUE



AW30235BLUE

AW30239BLUE

AW30240BLUE

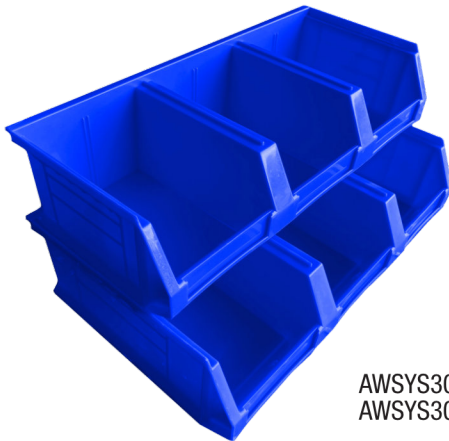

AWSYS30210BLUE
AWSYS30220BLUE



AWRAILBLUE



AWRAILBLACK

Model Number	Divider	Package Quantity
AW30210	AW40210BLACK	6
AW30220	AW40220BLACK	6
AW30230	AW40230BLACK	6
AW30235	AW40230BLACK	6
AW30239	AW40239BLACK	6
AW30240	AW40240BLACK	6
AW30250	AW40250BLACK	6
AWSYS30210	AW40210BLACK	6
AWSYS30220	AW40220BLACK	6

Hanging and Stacking Bins

Model Number	Description	Stocked Colours	Outside Dimensions (In.)			Inside Dimensions (In.)			Other Specifications		
			Length	Width	Height	Length	Width	Height	Weight (lbs)	Capacity (lbs)	Pallet Quantity
AW30210	5-3/8" x 4-1/8" x 3" Hanging and Stacking Bin	Blue	5.38	4.13	3.00	4.75	3.44	2.81	0.21	10.00	2880
AW30220	7-3/8" x 4-1/8" x 3" Hanging and Stacking Bin	Blue	7.38	4.13	3.00	6.75	3.44	2.81	0.29	10.00	1440
AW30230	10-7/8" x 5-1/2" x 5" Hanging and Stacking Bin	Blue	10.88	5.50	5.00	10.25	4.38	4.75	0.83	30.00	480
AW30235	10-7/8" x 11" x 5" Hanging and Stacking Bin	Blue	10.88	11.00	5.00	10.25	10.00	4.75	1.50	50.00	240
AW30239	10-7/8" x 8-1/8" x 7" Hanging and Stacking Bin	Blue	10.88	8.25	7.00	10.00	6.56	6.75	1.50	50.00	216
AW30240	14-3/4" x 8-1/8" x 7" Hanging and Stacking Bin	Blue	14.75	8.25	7.00	14.00	6.56	6.75	1.92	60.00	216
AW30250	14-3/4" x 16-1/2" x 7" Hanging and Stacking Bin	Blue	14.75	16.50	7.00	14.00	14.75	6.75	3.17	75.00	108
AWSYS30210	5-3/8" x 12-3/8" x 3" Hanging and Stacking System Bin	Blue	5.38	12.38	3.00	4.75	11.75	2.81	0.63	30.00	960
AWSYS30220	7-3/8" x 12-3/8" x 3" Hanging and Stacking Sustum Bin	Blue	7.38	12.38	3.00	6.75	11.75	2.81	0.87	30.00	480

*Other colours and customizations available with minimum order.

Shelf Bins:

Features/Benefits:

- Variety of sizes that work with standard steel and wire shelving, with gravity flow racking, or with deep racking.
- Resistant to weak acids, alkalis, water, rust, and corrosion proof.
- Visible label area for easy identification of contents.
- Outlasts corrugate bins by many years.

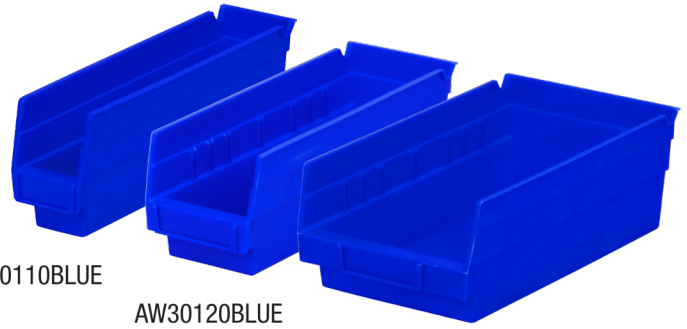

AW30110BLUE

AW30120BLUE

AW30130BLUE

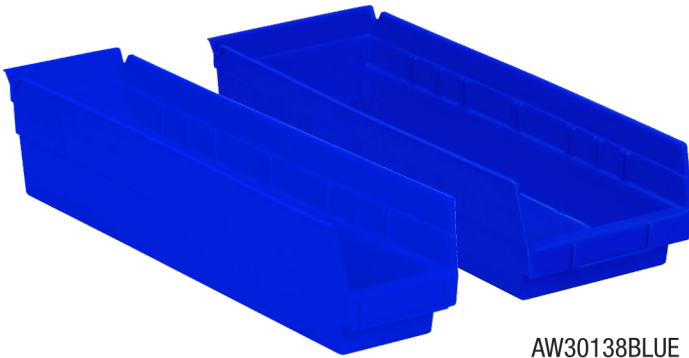

AW30138BLUE

AW30128BLUE



AW30550BLUE

AW30550BLUE with Hole

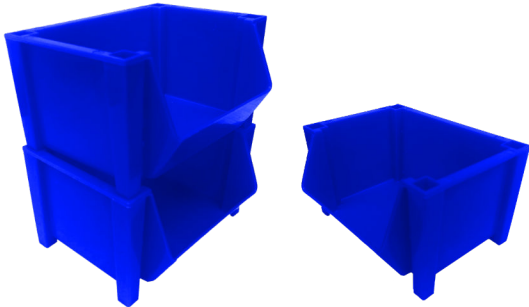

AW30105BLUE

AW40445BLACK

Model Number	Divider	Package Quantity
AW30105	-	-
AW30110	-	-
AW30120	AW40120BLACK	24
AW30128	AW40120BLACK	24
AW30130	AW40130BLACK	24
AW30138	AW40130BLACK	24
AW30550	-	-

Shelf Bins												
Model Number	Description	Stocked Colours	Outside Dimensions (In.)			Inside Dimensions (In.)			Other Specifications			
			Length	Width	Height	Length	Width	Height	Weight (lbs)	Capacity (lbs)	Pallet Quantity	
AW30105	3" x 3-1/2" x 2-1/8" Shelf Bin	Blue	3.00	3.50	2.13	2.50	3.25	1.75	0.15	1.00	2880	
AW30110	11-5/8" x 2-3/4" x 4" Shelf Bin	Blue	11.63	2.75	4.00	10.25	1.63	4.00	0.29	7.00	2304	
AW30120	11-5/8" x 4-1/8" x 4" Shelf Bin	Blue	11.63	4.13	4.00	10.25	3.00	4.00	0.38	10.00	17.28	
AW30128	17-7/8" x 4-1/8" x 4" Shelf Bin	Blue	17.88	4.13	4.00	16.50	3.00	4.00	0.58	15.00	960	
AW30130	11-5/8" x 6-5/8" x 4" Shelf Bin	Blue	11.63	6.63	4.00	10.25	5.50	4.00	0.51	15.00	1080	
AW30138	17-7/8" x 6-5/8" x 4" Shelf Bin	Blue	17.88	6.63	4.00	16.50	5.50	4.00	0.68	20.00	720	
AW30550	24" x 6" x 6" Shelf Bin	Blue	24.25	6.00	5.75	-	-	-	2.50	20.00	240	

*Other colours and customizations available with minimum order.

Stack, Nest and Hanging Bins:

Features/Benefits:

- Bins nest for shipping or storage.
- Stack without lids.
- Sit on shelving, hang on panels or rails.
- Made from Industrial grade polymers.
- Resistant to weak acids, alkalis, water, rust, and corrosion proof.
- Outlasts corrugate bins by many years.



AWSN30210BLUE

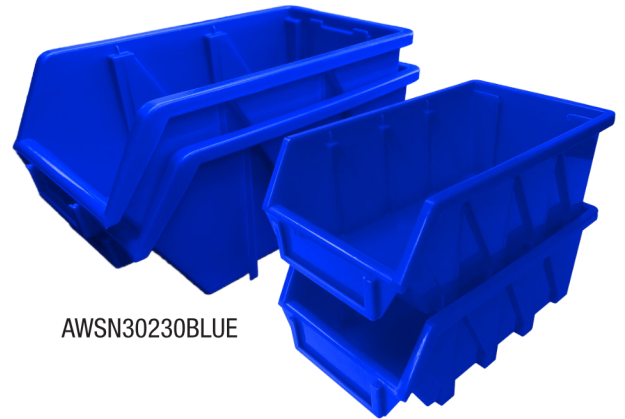

AWSN30230BLUE

AWSN30220BLUE

Stack, Nest and Hanging Bins

Model Number	Description	Stocked Colours	Outside Dimensions (In.)			Inside Dimensions (In.)			Other Specifications		
			Length	Width	Height	Length	Width	Height	Weight (lbs)	Capacity (lbs)	Pallet Quantity
AWSN30210	5-3/8" x 4-1/8" x 3" Stack, Nest and Hanging Bin	Blue	5.38	4.13	3.00	4.75	3.44	2.81	0.22	10.00	5760
AWSN30220	7-3/8" x 4-1/8" x 3" Stack, Nest and Hanging Bin	Blue	7.38	4.13	3.00	6.75	3.44	2.81	0.31	10.00	2880
AWSN30230	6-7/8" x 11" x 5" Stack, Nest and Hanging Bin	Blue	10.88	5.50	5.00	10.25	4.38	4.75	0.89	30.00	960

*Other colours and customizations available with minimum order.

High Visibility Stack Only Bins:

Features/Benefits:

- Large hopped front for maximum visibility of contents.
- Variety of sizes that work with standard steel and wire shelving, with gravity flow racking, or with deep racking.
- Resistant to weak acids, alkalis, water, rust, and corrosion proof.
- Visible label area for easy identification of contents.
- Outlasts corrugate bins by many years.

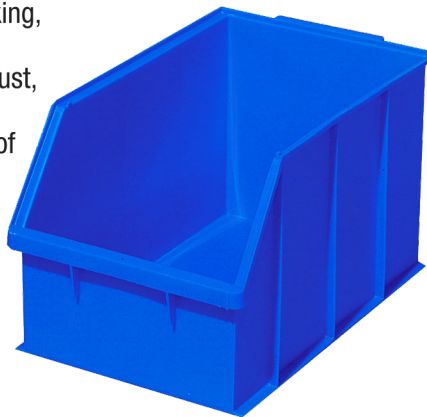

AW30600BLUE



AW30605BLUE

High Visibility Stack Only Bins

Model Number	Description	Stocked Colours	Outside Dimensions (In.)			Inside Dimensions (In.)			Other Specifications		
			Length	Width	Height	Length	Width	Height	Weight (lbs)	Capacity (lbs)	Pallet Quantity
AW30600	18" x 9" x 10" High Visibility Stacking Bin	Blue	18.00	9.37	10.00	16.50	8.00	9.80	2.67	50.00	80
AW30605	16" x 16" x 8" High Visibility Stacking Bin	Blue	16.00	16.00	8.19	14.50	14.50	8.00	2.30	50.00	132

*Other colours and customizations available with minimum order.

Promptlii

www.promptlii.com

Phone: (587) 287-2007